

# SHARP®

LIQUID CRYSTAL TELEVISION

# AQUOS androidtv

OPERATION MANUAL

- Please choose your favorite page from the content.  
If you want to close the operation manual, press the EXIT button.  
Also, if you want to return to the previously displayed page, press the  (Back) button.



Ultra HD 3840 x 2160

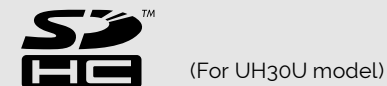
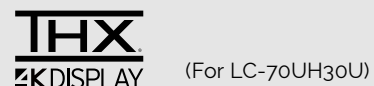

- 1. Part Names**
  - 1-1. TV
  - 1-2. Remote Control Unit
  - 1-4. Touchpad Remote Control Unit (For UH30U model)
- 2. How to select the TV Mode**
  - 2-1. Using the Remote Control Unit
  - 2-2. Using the Touchpad Remote Control Unit (For UH30U model)
  - 2-5. HOME screen
  - 2-6. Settings
  - Google Cast devices
  - 2-7. Channels
  - 2-8. Discover
  - 2-9. Devices
  - 2-10. TV Setup
- 3. TV Setup Operation**
  - 3-1. Introduction
  - 3-2. Picture
  - 3-24. Audio
  - 3-31. General
- 4. Devices Operation**
  - 4-1. Video In
  - 4-4. Audio Out
- 5. Direct Button Operation**
  - 5-1. Changing Channels
  - 5-2. Changing Volume
  - 5-3. MUTE
  - 5-4. FLASHBACK
  - 5-5. NETFLIX
  - 5-6. AUDIO
  - 5-7. Sleep Timer
  - 5-8. Closed Captions and Digital Closed Captions
  - 5-10. VIEW MODE
  - 5-13. Remote Control Panel
- 6. Enjoying Photo/Music/Video Playback**
  - 6-1. Preparation
  - 6-2. Selecting the Folders to Play Back
  - 6-4. Playing Back Files on a USB Memory Device/SD Memory Card/Home Network Server
  - 6-10. Playing Back Files from a Portable Device
- 7. Using LINK Operation**
  - 7-1. Presetting Remote Control Function
  - 7-4. Operating the Connected Equipment
  - 7-5. Controlling HDMI Equipment Using LINK Operation
  - 7-7. Using a Smartphone with the TV
- 8. Using a PC**
  - 8-1. Setting Audio Input
  - 8-2. Control of the TV
  - 8-8. PC Compatibility Chart
- 9. Using the Internet**
  - 9-1. Connecting to the Internet
  - 9-2. Using Keyboard and Mouse
  - 9-3. Notes
- 10. Appendix**
  - 10-1. Troubleshooting
  - 10-3. Troubleshooting - Error Message
  - 10-4. Information on the Software License for This Product
- 11. Trademarks**
- 12. Specifications**
  - 12-1. TV
  - 12-6. Wireless LAN
- 13. Dimensional Drawings**
  - 13-1. LC-80UH30U
  - 13-2. LC-70UH30U
  - 13-3. LC-80UE30U
  - 13-4. LC-70UE30U / LC-70UC30U
  - 13-5. LC-60UE30U



**IMPORTANT:**

To aid reporting in case of loss or theft, please record the TV's model and serial numbers in the space provided. The numbers are located at the rear and left side of the TV.

**WARNING:** TO REDUCE THE RISK OF FIRE OR ELECTRIC SHOCK, DO NOT EXPOSE THIS PRODUCT TO RAIN OR MOISTURE.

**CAUTION**

RISK OF ELECTRIC SHOCK  
DO NOT OPEN

CAUTION: TO REDUCE THE RISK OF ELECTRIC SHOCK, DO NOT REMOVE COVER (OR BACK). NO USER-SERVICEABLE PARTS INSIDE. REFER SERVICING TO QUALIFIED SERVICE PERSONNEL



The lightning flash with arrow-head symbol, within an equilateral triangle, is intended to alert the user to the presence of uninsulated "dangerous voltage" within the product's enclosure that may be of sufficient magnitude to constitute a risk of electric shock to persons.



The exclamation point within a triangle is intended to alert the user to the presence of important operating and maintenance (servicing) instructions in the literature accompanying the product.

**CAUTION:** TO PREVENT ELECTRIC SHOCK, MATCH WIDE BLADE OF PLUG TO WIDE SLOT, FULLY INSERT.

**WARNING:** FCC Regulations state that any unauthorized changes or modifications to this equipment not expressly approved by the manufacturer could void the user's authority to operate this equipment.

**CAUTION:** This product satisfies FCC regulations when shielded cables and connectors are used to connect the unit to other equipment. To prevent electromagnetic interference with electric appliances such as radios and televisions, use shielded cables and connectors for connections.

**DECLARATION OF CONFORMITY:**

SHARP LIQUID CRYSTAL TELEVISION, MODEL LC-80UH30U/LC-70UH30U/LC-80UE30U/LC-70UE30U/LC-60UE30U/LC-70UC30U

This device complies with Part 15 of the FCC Rules. Operation is subject to the following two conditions:

(1) This device may not cause harmful interference, and (2) this device must accept any interference received, including interference that may cause undesired operation.

**RESPONSIBLE PARTY:**

SHARP ELECTRONICS CORPORATION  
1 Sharp Plaza, Suite 1, Mahwah, NJ 07495-1123  
TEL: 1-800-BE-SHARP

For Business Customers: URL <http://www.sharpusa.com>

**INFORMATION:**

This equipment has been tested and found to comply with the limits for a Class B digital device, pursuant to Part 15 of the FCC Rules. These limits are designed to provide reasonable protection against harmful interference in a residential installation. This equipment generates, uses and can radiate radio frequency energy and, if not installed and used in accordance with the instructions, may cause harmful interference to radio communications. However, there is no guarantee that interference will not occur in a particular installation. If this equipment does cause harmful interference to radio or television reception, which can be determined by turning the equipment off and on, the user is encouraged to try to correct the interference by one or more of the following measures:

- Reorient or relocate the receiving antenna.
- Increase the separation between the equipment and receiver.
- Connect the equipment into an outlet on a circuit different from that to which the receiver is connected.
- Consult the dealer or an experienced radio/TV technician for help.

**FCC Compliance Statement**

This device complies with part 15 of the FCC Rules. Operation is subject to the following two conditions:  
(1) This device may not cause harmful interference, and (2) this device must accept any interference received, including interference that may cause undesired operation.

**Wireless Radio**

For product available in the USA/Canada market, only channel 1–11 can be operated. Selection of other channels is not possible. This device is going to be operated in 5.15–5.25GHz frequency range, it is restricted in indoor environment only.

**Important:** Any changes or modifications not expressly approved by the party responsible for compliance could void the user's authority to operate the equipment.

**FCC Radiation Exposure Statement:** This equipment complies with FCC radiation exposure limits set forth for an uncontrolled environment. This equipment should be installed and operated with minimum distance 20cm between the radiator & your body.

**Industry Canada Statement**

This Class B digital apparatus complies with CAN ICES-003(B)/NMB-3(B)

**Wireless Radio**

For product available in the USA/Canada market, only channel 1–11 can be operated. Selection of other channels is not possible.

The device could automatically discontinue transmission in case of absence of information to transmit, or operational failure.

Note that this is not intended to prohibit transmission of control or signaling information or the use of repetitive codes where required by the technology.

**Important:** Any changes or modifications not expressly approved by the party responsible for compliance could void the user's authority to operate the equipment.

**IC Radiation Exposure Statement:** This device complies with IC RSS-210 rules; Operation is subject to the following two conditions:

(1) This device may not cause harmful interference, and (2) this device must accept interference received, including interference that may cause undesired operation.

"Note to CATV system installer: This reminder is provided to call the CATV system installer's attention to Article 820 of the National Electrical Code that provides guidelines for proper grounding and, in particular, specifies that the cable ground shall be connected to the grounding system of the building, as close to the point of cable entry as practical."

## DEAR SHARP CUSTOMER

Thank you for your purchase of the Sharp Liquid Crystal Television. To ensure safety and many years of trouble-free operation of your product, please read the Important Safety Instructions carefully before using this product.

## IMPORTANT SAFETY INSTRUCTIONS

Electricity is used to perform many useful functions, but it can also cause personal injuries and property damage if improperly handled. This product has been engineered and manufactured with the highest priority on safety. However, improper use can result in electric shock and/or fire. In order to prevent potential danger, please observe the following instructions when installing, operating and cleaning the product. To ensure your safety and prolong the service life of your Liquid Crystal Television, please read the following precautions carefully before using the product.

- 1) Read these instructions.
- 2) Keep these instructions.
- 3) Heed all warnings.
- 4) Follow all instructions.
- 5) Do not use this apparatus near water.
- 6) Clean only with dry cloth.
- 7) Do not block any ventilation openings. Install in accordance with the manufacturer's instructions.
- 8) Do not install near any heat sources such as radiators, heat registers, stoves, or other apparatus (including amplifiers) that produce heat.
- 9) Do not defeat the safety purpose of the polarized or grounding-type plug. A polarized plug has two blades with one wider than the other. A grounding type plug has two blades and a third grounding prong. The wide blade or the third prong are provided for your safety. If the provided plug does not fit into your outlet, consult an electrician for replacement of the obsolete outlet.
- 10) Protect the power cord from being walked on or pinched particularly at plugs, convenience receptacles, and the point where they exit from the apparatus.
- 11) Only use attachments/accessories specified by the manufacturer.
- 12) Use only with the cart, stand, tripod, bracket, or table specified by the manufacturer, or sold with the apparatus. When a cart is used, use caution when moving the cart/apparatus combination to avoid injury from tip-over.
- 13) Unplug this apparatus during lightning storms or when unused for long periods of time.
- 14) Refer all servicing to qualified service personnel. Servicing is required when the apparatus has been damaged in any way, such as power-supply cord or plug is damaged, liquid has been spilled or objects have fallen into the apparatus, the apparatus has been exposed to rain or moisture, does not operate normally, or has been dropped.



### Additional Safety Information

- 15) Power Sources—This product should be operated only from the type of power source indicated on the marking label. If you are not sure of the type of power supply to your home, consult your product dealer or local power company. For products intended to operate from battery power, or other sources, refer to the operating instructions.
- 16) Overloading—Do not overload wall outlets, extension cords, or integral convenience receptacles as this can result in a risk of fire or electric shock.
- 17) Object and Liquid Entry—Never push objects of any kind into this product through openings as they may touch dangerous voltage points or short-out parts that could result in a fire or electric shock. Never spill liquid of any kind on the product.
- 18) Damage Requiring Service—Unplug this product from the wall outlet and refer servicing to qualified service personnel under the following conditions:
  - a) When the AC cord or plug is damaged,
  - b) If liquid has been spilled, or objects have fallen into the product,
  - c) If the product has been exposed to rain or water,
  - d) If the product does not operate normally by following the operating instructions.
 Adjust only those controls that are covered by the operating instructions as an improper adjustment of other controls may result in damage and will often require extensive work by a qualified technician to restore the product to its normal operation,

ENG Important3

## IMPORTANT SAFETY INSTRUCTIONS

- e) If the product has been dropped or damaged in any way, and
- f) When the product exhibits a distinct change in performance - this indicates a need for service.
- 19) Replacement Parts—When replacement parts are required, be sure the service technician has used replacement parts specified by the manufacturer or have the same characteristics as the original part. Unauthorized substitutions may result in fire, electric shock, or other hazards.
- 20) Safety Check—Upon completion of any service or repairs to this product, ask the service technician to perform safety checks to determine that the product is in proper operating condition.
- 21) Wall or ceiling mounting—When mounting the product on a wall or ceiling, be sure to install the product according to the method recommended by the manufacturer.

- Outdoor Antenna Grounding — If an outside antenna is connected to the television equipment, be sure the antenna system is grounded so as to provide some protection against voltage surges and built-up static charges. Article 810 of the National Electrical Code, ANSI/NFPA 70, provides information with regard to proper grounding of the mast and supporting structure, grounding of the lead-in wire to an antenna discharge unit, size of grounding conductors, location of antenna-discharge unit, connection to grounding electrodes, and requirements for the grounding electrode.

EXAMPLE OF ANTENNA GROUNDING AS PER NATIONAL ELECTRICAL CODE, ANSI/NFPA 70

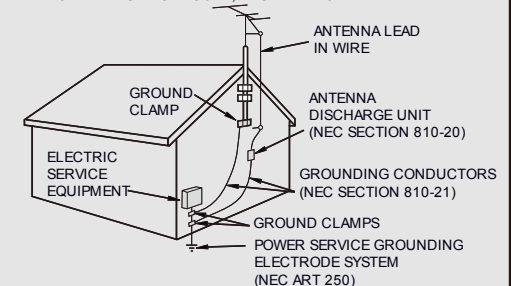

NEC — NATIONAL ELECTRICAL CODE

- Water and Moisture — Do not use this product near water - for example, near a bath tub, wash bowl, kitchen sink, or laundry tub; in a wet basement; or near a swimming pool; and the like.
- Stand — Do not place the product on an unstable cart, stand, tripod or table. Placing the product on an unstable base can cause the product to fall, resulting in serious personal injuries as well as damage to the product. Use only a cart, stand, tripod, bracket or table recommended by the manufacturer or sold with the product. When mounting the product on a wall, be sure to follow the manufacturer's instructions. Use only the mounting hardware recommended by the manufacturer.
- Selecting the location — Select a place with no direct sunlight and good ventilation.
- Ventilation — The vents and other openings in the cabinet are designed for ventilation. Do not cover or block these vents and openings since insufficient ventilation can cause overheating and/or shorten the life of the product. Do not place the product on a bed, sofa, rug or other similar surface, since they can block ventilation openings. This product is not designed for built-in installation; do not place the product in an enclosed place such as a bookcase or rack, unless proper ventilation is provided or the manufacturer's instructions are followed.
- The front panel used in this product is made of glass. Therefore, it can break when the product is dropped or applied with impact. Be careful not to be injured by broken glass pieces in case the panel breaks.
- Heat — The product should be situated away from heat sources such as radiators, heat registers, stoves, or other products (including amplifiers) that produce heat.
- The Liquid Crystal panel is a very high technology product with 8,294,400 pixels, giving you fine picture details. Occasionally, a few non-active pixels may appear on the screen as a fixed point of blue, green or red. Please note that this does not affect the performance of your product.
- Lightning — For added protection for this television equipment during a lightning storm, or when it is left unattended and unused for long periods of time, unplug it from the wall outlet and disconnect the antenna. This will prevent damage to the equipment due to lightning and power-line surges.
- Power Lines — An outside antenna system should not be located in the vicinity of overhead power lines or other electric light or power circuits, or where it can fall into such power lines or circuits. When installing an outside antenna system, extreme care should be taken to keep from touching such power lines or circuits as contact with them might be fatal.
- To prevent fire, never place any type of candle or flames on the top or near the TV set.
- To prevent fire or shock hazard, do not place the AC cord under the TV set or other heavy items.

## IMPORTANT SAFETY INSTRUCTIONS

- Do not display a still picture for a long time, as this could cause an afterimage to remain.
- To prevent fire or shock hazard, do not expose this product to dripping or splashing. No objects filled with liquids, such as vases, should be placed on the product.
- Do not insert foreign objects into the product. Inserting objects in the air vents or other openings may result in fire or electric shock. Exercise special caution when using the product around children.



### Precautions when transporting the TV

- When transporting the TV, never carry it by holding or otherwise putting pressure onto the display. Be sure to always carry the TV by two people (80 inch models: three people) holding it with two hands.



### Do not install the TV in a location in which it will be subject to water drops such as underneath an air conditioning unit or in the vicinity of a humidifier

- Water drops falling onto the TV and water entering inside it may result in fire, electric shock, or malfunctions. We recommend that you install the TV at least 3.3 ft (1 m) away from the outlet of an air conditioner.

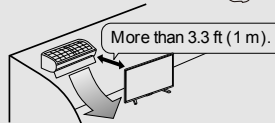

### Caring for the cabinet

- Use a soft cloth (cotton, flannel, etc.) and gently wipe the surface of the cabinet.
- Using a chemical cloth (wet/dry sheet type cloth, etc.) may deform the components of the main unit cabinet or cause cracking.
- Wiping with a hard cloth or using strong force may scratch the surface of the cabinet.
- If the cabinet is very dirty, wipe with a soft cloth (cotton, flannel, etc.) soaked in neutral detergent diluted with water and thoroughly wrung out, and then wipe with a soft dry cloth.
- Avoid using benzene, thinner, and other solvents, as these may deform the cabinet and cause the paint to peel off.
- Do not apply insecticides or other volatile liquids. Also, do not allow the cabinet to remain in contact with rubber or vinyl products for a long period of time. Plasticizers inside the plastic may cause the cabinet to deform and cause the paint to peel off.

### Caring for the front panel

- Turn off the main power and unplug the AC cord from the wall outlet before handling.
- Gently wipe the surface of the front panel with a soft cloth (cotton, flannel, etc.). To protect the front panel, do not use a dirty cloth, liquid cleaners, or a chemical cloth (wet/dry sheet type cloth, etc.). This may damage the surface of the front panel.
- Wiping with a hard cloth or using strong force may scratch the surface of the front panel.
- Use a soft damp cloth to gently wipe the front panel when it is really dirty. (It may scratch the surface of the front panel when wiped strongly.)
- If the front panel is dusty, use an anti-static brush, which is commercially available, to clean it.
- To avoid scratching the frame or screen, please use a soft, lint free cloth for cleaning. Approved cleaning cloths are available directly from Sharp in single (00Z-LCD-CLOTH) or triple (00Z-LCD-CLOTH-3) packs. Call 1-800-BE-SHARP for ordering, or VISIT <http://www.sharpsusa.com>



## CHILD SAFETY:

### PROPER TELEVISION PLACEMENT MATTERS



### THE CONSUMER ELECTRONICS INDUSTRY CARES

- Manufacturers, retailers and the rest of the consumer electronics industry are committed to making home entertainment safe and enjoyable.
- As you enjoy your television, please note that all televisions – new and old – must be supported on proper stands or installed according to the manufacturer's recommendations. Televisions that are inappropriately situated on dressers, bookcases, shelves, desks, speakers, chests, carts, etc., may fall over, resulting in injury.

### TUNE IN TO SAFETY

- **ALWAYS** follow the manufacturer's recommendations for the safe installation of your television.
- **ALWAYS** read and follow all instructions for proper use of your television.
- **NEVER** allow children to climb on or play on the television or the furniture on which the television is placed.
- **NEVER** place the television on furniture that can easily be used as steps, such as a chest of drawers.
- **ALWAYS** install the television where it cannot be pushed, pulled over or knocked down.
- **ALWAYS** route cords and cables connected to the television so that they cannot be tripped over, pulled or grabbed.

### WALL OR CEILING MOUNT YOUR TELEVISION

- **ALWAYS** contact your retailer about professional installation if you have any doubts about your ability to safely mount your television.
- **ALWAYS** use a mount that has been recommended by the television manufacturer and has a safety certification by an independent laboratory (such as UL, CSA, ETL).
- **ALWAYS** follow all instructions supplied by the television and mount manufacturers.
- **ALWAYS** make sure that the wall or ceiling where you are mounting the television is appropriate. Some mounts are not designed to be mounted to walls and ceilings with steel studs or cinder block construction. If you are unsure, contact a professional installer.
- Televisions can be heavy. A minimum of two people is required for a wall or ceiling mount installation.

### MOVING AN OLDER TELEVISION TO A NEW PLACE IN YOUR HOME

- Many new television buyers move their older CRT televisions into a secondary room after the purchase of a flat-panel television. Special care should be made in the placement of older CRT televisions.
- **ALWAYS** place your older CRT television on furniture that is sturdy and appropriate for its size and weight.
- **NEVER** place your older CRT television on a dresser where children may be tempted to use the drawers to climb.
- **ALWAYS** make sure your older CRT television does not hang over the edge of your furniture.

CEA.org/safety



## IMPORTANT SAFETY INSTRUCTIONS

---

### Wireless LAN

This TV has received the following certifications.

- Wi-Fi CERTIFIED™ (certification program from the Wi-Fi Alliance® )
- Wi-Fi Protected Setup™ (certification program from the Wi-Fi Alliance® )

### FCC

This device complies with part 15 of the FCC Rules. Operation is subject to the following two conditions:

(1) This device may not cause harmful interference, and (2) this device must accept any interference received, including interference that may cause undesired operation. Changes or modifications not expressly approved by the party responsible for compliance could void the user's authority to operate the equipment. To comply with the FCC RF exposure compliance requirements, this device and its antenna must not be co-located or operated in conjunction with any other antenna or transmitter.

The device for the band 5150-5250 MHz is only for indoor usage to reduce potential for harmful interference to co-channel mobile satellite systems;

The maximum antenna gain permitted (for devices in the bands 5250-5350 MHz and 5470-5725 MHz) to comply with the e.i.r.p. limit; and High-power radars are allocated as primary users (meaning they have priority) of the bands 5250-5350 MHz and 5650-5850 MHz and these radars could cause interference and/or damage to LE-LAN devices.

## IMPORTANT SAFETY INSTRUCTIONS

### Bluetooth

#### Notes on Radio Wave Certification in the U.S.A. and Canada

This device complies with part 15 of the FCC Rules. Operation is subject to the following two conditions: (1) This device may not cause harmful interference, and (2) this device must accept any interference received, including interference that may cause undesired operation.

"This transmitter must not be co-located or operated in conjunction with any other antenna or transmitter."

#### FCC/INDUSTRY CANADA NOTICE

This device complies with Part 15 of FCC Rules and Industry Canada license-exempt RSS standard(s).

Operation is subject to the following two conditions: (1) this device may not cause interference, and (2) this device must accept any interference, including interference that may cause undesired operation of this device.

This equipment complies with FCC/IC radiation exposure limits set forth for an uncontrolled environment and meets the FCC radio frequency (RF) Exposure Guidelines in Supplement C to OET65 and RSS-102 of the IC radio frequency (RF) Exposure rules. This equipment has very low levels of RF energy that are deemed to comply without testing of specific absorption ratio (SAR).

#### FCC CAUTION

Changes or modifications not expressly approved by Hosiden responsible for compliance could void the user's authority to operate the equipment.

Note: This equipment has been tested and found to comply with the limits for a Class B digital device, pursuant to Part 15 of the FCC Rules. These limits are designed to provide reasonable protection against harmful interference in a residential installation. This equipment generates, uses and can radiate radio frequency energy and, if not installed and used in accordance with the instructions, may cause harmful interference to radio communications. However, there is no guarantee that interference will not occur in a particular installation. If this equipment does cause harmful interference to radio or television reception, which can be determined by turning the equipment off and on, the user is encouraged to try to correct the interference by one or more of the following measures:

Reorient or relocate the receiving antenna.

Increase the separation between the equipment and receiver.

Connect the equipment into an outlet on a circuit different from that to which the receiver is connected.

Consult the dealer or an experienced radio/TV technician for help.

This Class B digital apparatus complies with Canadian ICES-003

Le présent appareil est conforme aux la partie 15 des règles de la FCC et CNR d'Industrie Canada applicat aux appareils radio exempts de licence. L'exploitation est autorisée aux deux conditions suivantes : (1) l'appareil ne doit pas produire de brouillage, et (2) l'utilisateur de l'appareil doit accepter tout brouillage radioélectrique subi, même si le brouillage est susceptible d'en compromettre le fonctionnement. Cet équipement est conforme aux limites d'exposition aux rayonnements énoncées pour un environnement non contrôlé et respecte les règles les radioélectriques (RF) de la FCC lignes directrices d'exposition dans le Supplément C à OET65 et d'exposition aux fréquences radioélectriques (RF) CNR-102 de l'IC. Cet équipement émet une énergie RF très faible qui est considérée conforme sans évaluation du débit d'absorption spécifique (DAS).

Cet appareil numérique de la classe B est conforme à la norme NMB-3 du Canada.



## TV

## (Front)

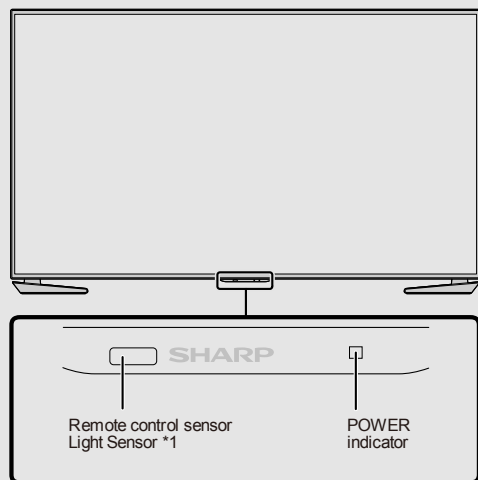

\*1 [See page 3-4.](#)

## (Side)

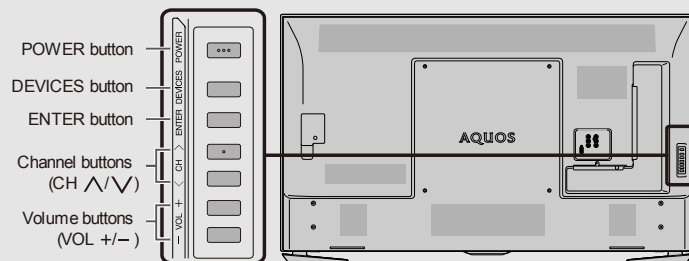

- The illustrations and on-screen displays in this operation manual are for explanation purposes and may vary slightly from the actual operations.
- The drawings used throughout this manual are based on the LC-60UE30U model.

## (Rear)

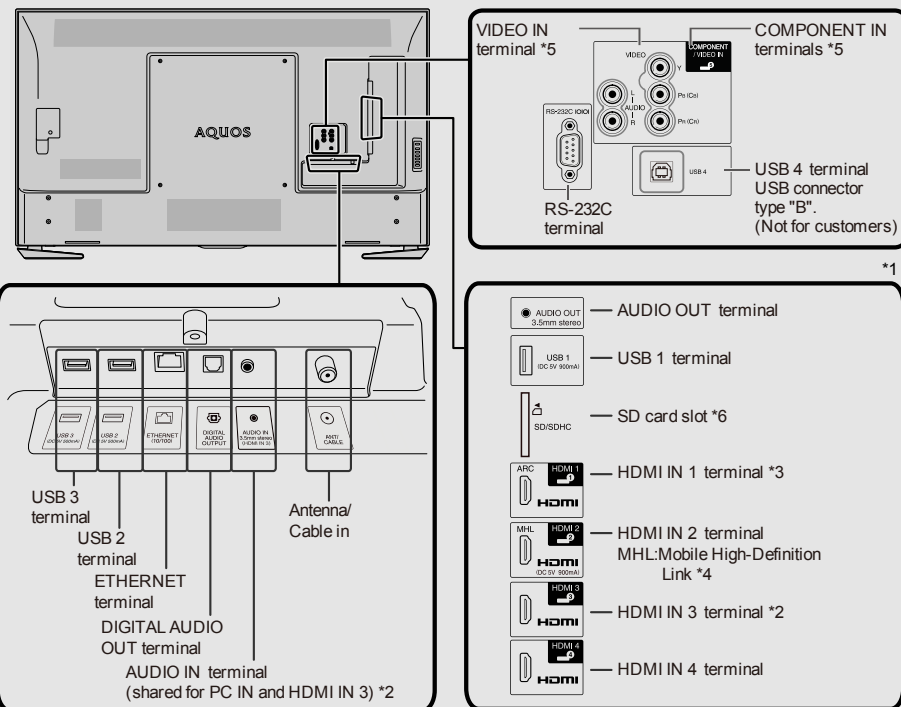

- HDMI IN 1, 2, 3 and 4 terminals are all capable of receiving 4K60P 4:4:4 signals.  
To receive 4K60P 4:4:4 signals, on the Devices menu, set the HDMI type to "Full". ([See page 4-1](#))

\*1 [See the Setup Guide.](#) And [see page 7-5](#) for external equipment connection.

\*2 [See page 8-1](#) for details on the Audio Select function.

\*3 Use HDMI IN 1 to connect ARC-compatible equipment.

\*4 [See page 7-7.](#)

\*5 [See page 4-3](#) for details on the Component/Video select function.

\*6 For UH30U model only.

## Remote Control Unit



**1 POWER:** Switch the TV power on or enter standby.

**2 TV, STB, DVD-VCR, AUDIO:** Switches the remote control for TV, STB, BD, DVD, VCR and AUDIO operation.

[\(See pages 7-1 to 7-4 for details.\)](#)

\* To enter the code registration mode, you need to press an appropriate button (STB, DVD-VCR or AUDIO) and MANUAL at the same time.

**3 External equipment operational buttons:** Operate the external equipment.

**4 DISPLAY:** Display the channel information.

**5 SLEEP:** Set the sleep timer.

[\(See page 5-7.\)](#)

**6 0-9:** Set the channel.

[\(See pages 5-1 and 7-4.\)](#)

**7 · (DOT):** Set the channel.

[\(See pages 5-1 and 7-4.\)](#)

**8 CC:** Display captions from a closed-caption source.

[\(See page 5-8 to 5-9\)](#)

**9 AV MODE:** Select an audio or video setting.

[\(See page 3-2.\)](#)

**10 MUTE:** Mute the sound.

[\(See page 5-3.\)](#)

**11 VOL+/-:** Set the volume.

[\(See page 5-2.\)](#)

**12**  (TV Setup): Display the TV Setup screen.

[\(See page 2-10.\)](#)

**13** (Channels): Display the Channels screen.

[\(See page 2-7.\)](#)

**14** ▲ / ▼ / ◀ / ▶ , ● (ENTER): Select a desired item on the screen.

**15** (Back): Return to the previous screen.

**16 EXIT:** Turn off the menu screen and application.

**17 A, B, C, D:** The colored buttons are correspondingly used to select the colored items on the screen.

**18 MANUAL:** Display the operation manual.

**19 POWER (SOURCE):** Turns the power of the external equipment on and off.

## Remote Control Unit (Continue)



**20 MORE:** Display the Remote Control Panel.

[\(See page 5-13.\)](#)

**21 AUDIO:** Selects the MTS/SAP or the audio mode during multichannel audio broadcasts.

[\(See page 5-6.\)](#)

**22 ENT:** Jumps to a channel after selecting with the 0-9 buttons.

**23 FLASHBACK:** Return to the previous channels, HDMI IN 1 through 4, or video/Component input mode.

[\(See page 5-4.\)](#)

**24 VIEW MODE:** Select the screen size.

[\(See pages 5-10 to 5-12.\)](#)

**25 (Devices):** Display the Devices screen.

Select a TV input source.

[\(See page 2-9.\)](#)

**26 CH ^ / v:** Select the channel.

[\(See page 5-1.\)](#)

**27 (Discover):** Display the Discover screen.

[\(See page 2-8.\)](#)

**28 (HOME):** Display the HOME screen.

[\(See page 2-1 and 2-5.\)](#)

**29 NETFLIX:** Display the NETFLIX screen.

If you press the NETFLIX button when the TV is turned off, the TV turns on and the NETFLIX screen is displayed.

[\(See page 5-5.\)](#)

**30 FAVORITE 1, 2, 3:** You can assign your favorite channels to these buttons.

[\(See page 3-36.\)](#)

## Touchpad Remote Control Unit (For UH30U model)



**1 Power:** Switch the TV power on or enter standby.

Infrared rays are only used when you press the POWER button and NETFLIX button on the Touchpad Remote Control Unit, so you only have to point the unit at the remote control sensor when you press this button.

**2 MORE:** Display the Remote Control Panel.

[\(See page 5-13.\)](#)

**3 (Channels) /  (Discover) / (Devices) / (TV Setup):** Display the Channels/Discover/Devices/TV Setup screen.

[\(See pages 2-7 to 2-10.\)](#)

**4 Slide bar:** Can be used to display the Channels/Discover/Devices/TV Setup screen.

[\(See pages 2-2.\)](#)

**5 Touchpad:** In Mouse mode, touch this to perform operations. In Flick mode, flick your finger up, down, left, or right to move the focus.

[\(See pages 2-3 to 2-4.\)](#)

**6 (Back):** Return to the previous screen.

**7 VOL+/-:** Set the volume.

[\(See page 5-2.\)](#)

**8 MUTE:** Mute the sound.

[\(See page 5-3.\)](#)

**9 External equipment operational buttons:** Operate the external equipment.

**10 Mouse/Flick mode switch button:** Switch the touchpad between Mouse mode and Flick mode.

[\(See page 2-2.\)](#)

**11 EXIT:** Turn off the menu screen and application.

**12  (HOME):** Display the HOME screen.

[\(See page 2-1 and 2-5.\)](#)

**13 CH  $\wedge$  /  $\vee$ :** Select the channel.

[\(See page 5-1.\)](#)

**14 NETFLIX:** Display the NETFLIX screen.

[\(See page 5-5.\)](#)

**15 Voice:** Start a Voice search.

[\(See page 2-4.\)](#)

**16 Microphone:** Used in Voice searches and apps. When you are using the microphone, do not cover this part with your hand.

[\(See page 2-4.\)](#)

## Using the Remote Control Unit

The main TV modes can be displayed by pressing the **(Channels)**, **(Discover)**, **(Devices)**, and **(TV Setup)** buttons on the remote control unit.

### HOME screen

Press **(HOME)** to display the HOME screen.



Example

You can access Search, Recommended, Apps, Games, Inputs, and Settings. [See page 2-5](#) for details.

### Devices

Press **(Devices)** again to display the Devices full screen.

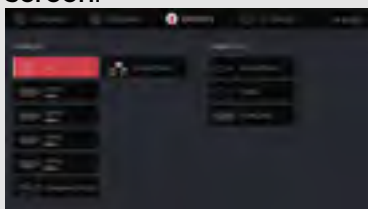

Press **(Devices)** to display the Devices peek screen.

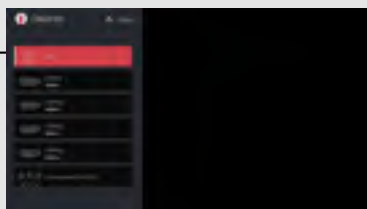

[See page 2-9](#) and [4-1 to 4-6](#) for details of Devices.

### TV Setup

Press **(TV Setup)** again to display the TV Setup full screen.

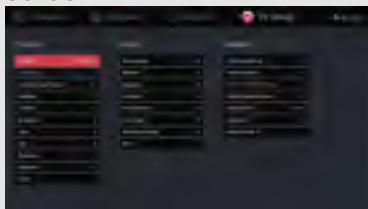

Press **(TV Setup)** to display the TV Setup peek screen.

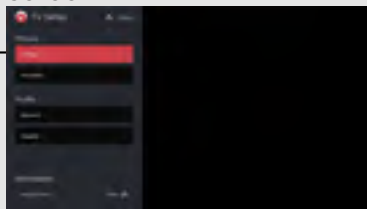

[See page 2-10](#) and [3-1 to 3-45](#) for details of TV Setup.

### Discover

Press **(Discover)** to display the Discover peek screen.

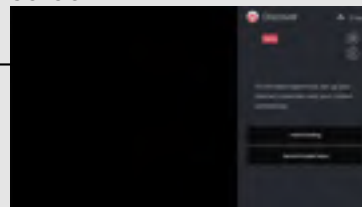

Press **(Discover)** again to display the Discover full screen.

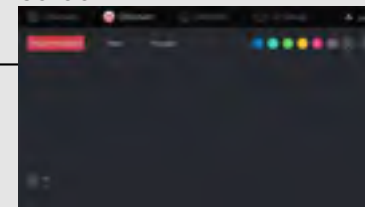

[See page 2-8](#) for details of Discover.

### Channels

Press **(Channels)** to display the Channels peek screen.

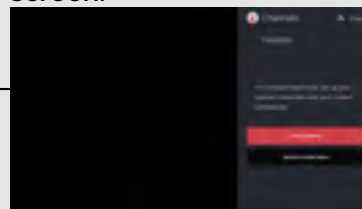

Press **(Channels)** again to display the Channels full screen.

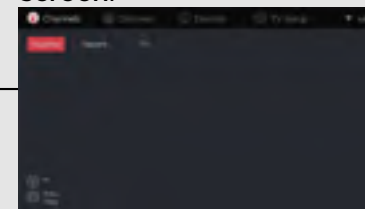

[See page 2-7](#) for details of Channels.

### NOTE

- Pressing the button again when a mode's full screen is displayed will cause the screen to return to the current broadcast.
- If a mode is started while viewing the Apps screen, the screen will return to the channel or external input viewed immediately before the mode was started. To show the Apps screen again, repeat the operation from the beginning.

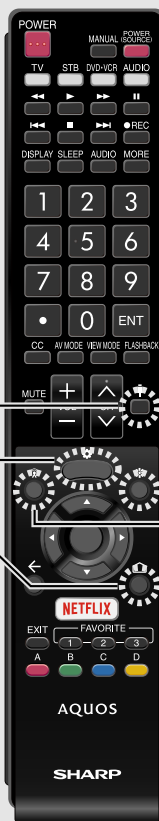



## Using the Touchpad Remote Control Unit (For UH30U model)

### Preparation

Before using the Touchpad Remote Control Unit, you have to follow the procedure shown below to pair the unit with the TV.

- 1 Select "HOME" > "Settings" > "Remote & accessories" > "Add accessory".
- 2 Press the **(HOME)** and **(Back)** buttons on the Touchpad Remote Control Unit at the same time for 5 seconds.  
About 20 seconds later, "SHARP Remote control device" is shown on TV screen.
- 3 Select "SHARP Remote control device" on TV screen, and then press **(ENTER)** on the IR Remote Control.  
About 5-10 seconds later, PAIRED is shown. Preparation is complete.

### NOTE

- In preparation 3, if COULDN'T PAIR is shown, please try "preparation 1-3" again.
- Pairing success/failure may be influenced by the surrounding wireless/RF environment.

### Mouse/Flick mode switch button

Switch the touchpad between Mouse mode and Flick mode.

### NOTE

- The default is Flick mode.
- Some apps may not function in Mouse mode. If an app does not function, switch to Flick mode.

(Channels) / (Discover) /  (Devices) / (TV Setup)

Display the Channels/Discover/Devices/TV Setup screen.

### Slide bar

You can slide to display the Channels/Discover/Devices/TV Setup screen.

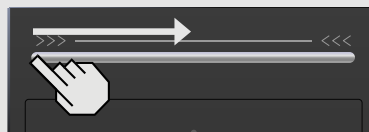

- Slide from the left edge to the center to display the Devices or TV Setup peek screen.
- Slide from the left edge to the right edge to display the Devices or TV Setup full screen.

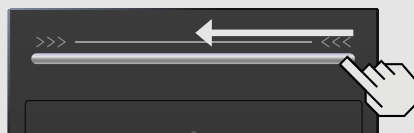

- Slide from the right edge to the center to display the Channels or Discover peek screen.
- Slide from the right edge to the left edge to display the Channels or Discover full screen.

ENG 2-2

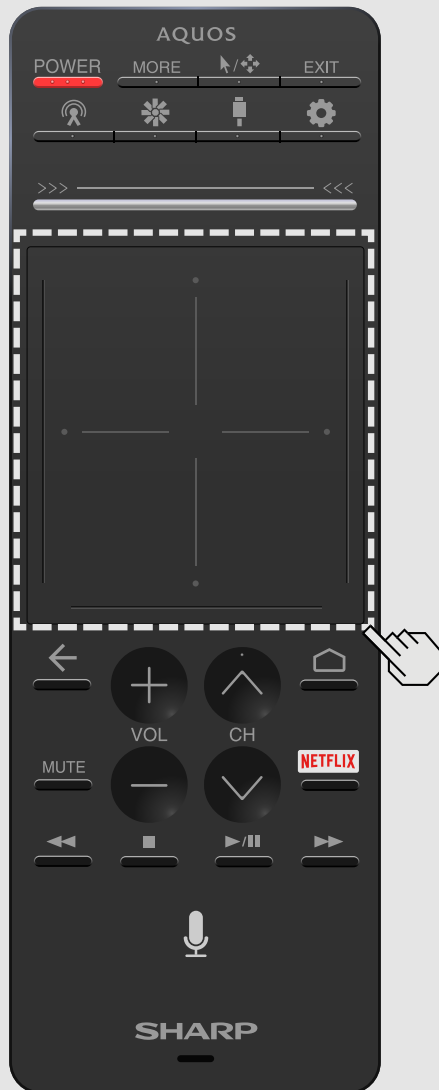

## Using the Touchpad Remote Control Unit (Continue) (For UH30U model)

### Touchpad

Switch between Mouse mode and Flick mode when using the touchpad.  
Use the Mouse/Flick mode switch button to switch between Mouse mode and Flick mode.  
The following operations can be performed in Flick mode and Mouse mode.

### NOTE

- If you perform no operations on the touchpad remote control unit for 1 minute or longer, it will enter Sleep mode. You can return the touchpad remote control unit from Sleep mode by pressing the center of the touchpad. However, it will take the touchpad remote control unit 2 to 3 seconds to return from Sleep mode.

### Flick mode

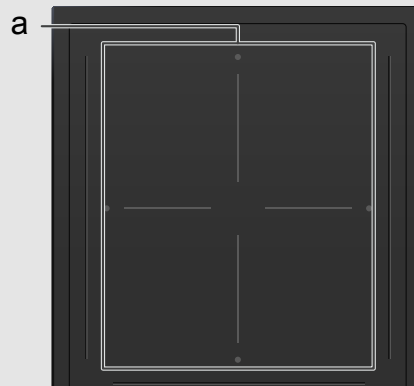

Press the touchpad or slide your fingers across it to operate the TV.

- Slide one finger horizontally or vertically: Move the focus.
- Press a "." mark with a finger: Move up, down, left, or right.
- Press the center with a finger: Confirm a selection.

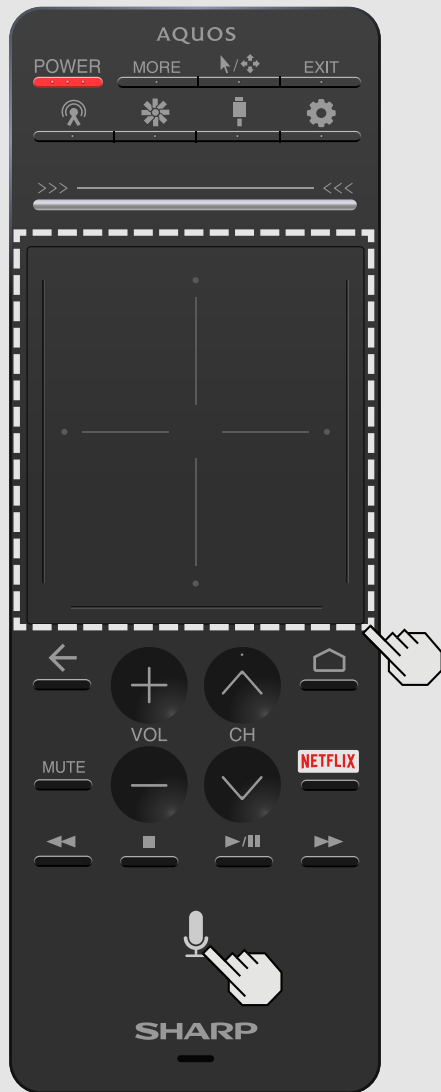

## Using the Touchpad Remote Control Unit (Continue) (For UH30U model)

### Touchpad

#### Mouse mode

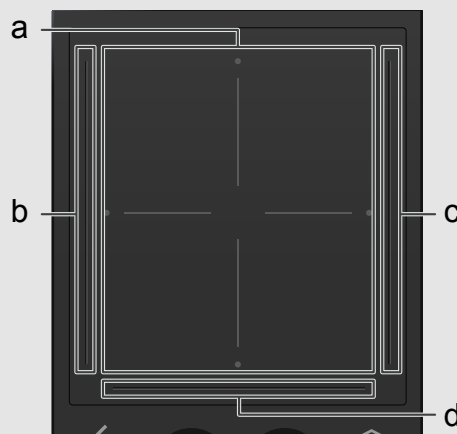

a	<p>You can perform the following operations.</p> <ul style="list-style-type: none"> <li>• Move one finger: Perform the same movement as moving a mouse.</li> <li>• Click (press the touchpad): Perform the same operation as clicking a mouse.</li> </ul>
b/c	<p>Scroll bars Can be used to scroll vertically through screens.</p>
d	<p>Scroll bar Can be used to scroll horizontally through screens.</p>

#### NOTE

- If the AC plug is disconnected, the touchpad remote control unit will return to Flick mode.

### Voice

Start a Voice search.

Speak the word that you want to search for into the microphone at the bottom of the remote control.

When you are using the microphone, do not cover this part with your hand.

#### NOTE

- The Voice search may not start depending on the status of the TV.

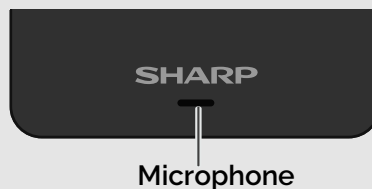



## HOME screen

To display the HOME screen, press the (HOME) button on the remote control unit.

## Example



- ① Start a Search.
- ② The recommended contents will be displayed.

## NOTE

- When you are using the microphone, [see page 2-4](#).

## Example

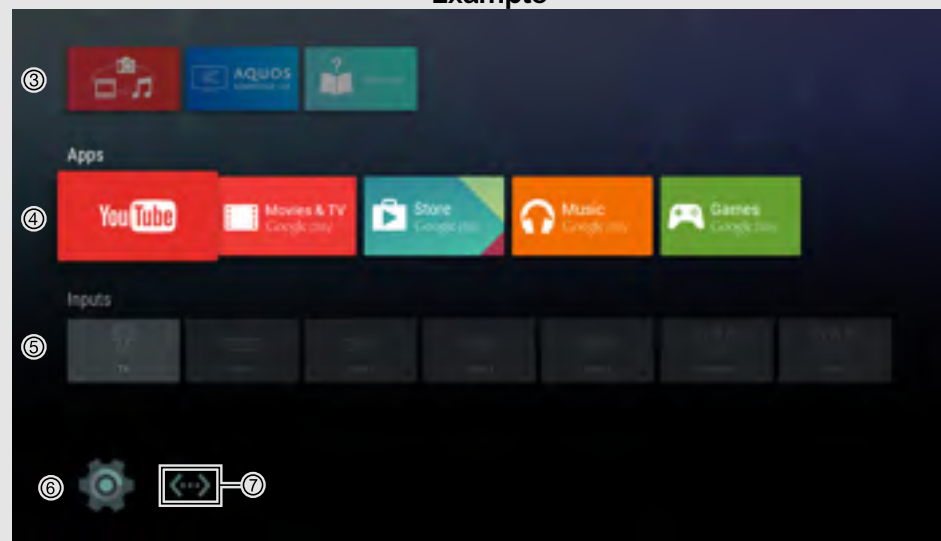

- ③ The icons for applications installed on the TV are shown here. Also shown here is an icon for the built-in operation manual.
- ④ Added applications are displayed here.
- ⑤ Switch the input.
- ⑥ Various Android™ settings can be configured here. For details on the settings, see the next page.
- ⑦ The network connection status is displayed.

Wireless connection: 

Ethernet connection: 

No connection: 

## Settings

Various Android settings can be configured from Settings on the HOME screen. The follow settings can be configured.

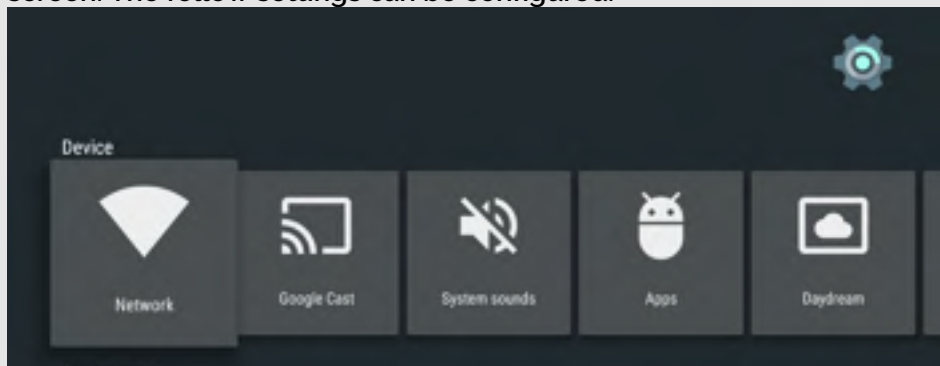

Device	<b>Network:</b> Configure the WiFi and Ethernet settings.	
	<b>Google Cast:</b> Configure various Google Cast™ settings.	
	<b>System sounds:</b> Switch System Sounds On/Off for HOME screen.	
	<b>Apps:</b> View a list of applications.	
	<b>Daydream</b>	<b>Daydream:</b> Configure the Daydream (screensaver) settings.
		<b>When to daydream:</b> Set how many minutes from now to start the Daydream.
		<b>No operation OFF:</b> The TV automatically shuts down if no operation is performed.
		<b>Start now:</b> Start the Daydream immediately.
	<b>Control</b>	<b>Power Indicator Light:</b> When this function is set to "On", the LED on the front of the TV turns on.
		<b>Power Control</b> <b>【ECO1】 Standard:</b> Optimizes power reduction based upon video content. <b>【ECO2】 Advanced:</b> Optimizes power reduction based upon video content and engages Light Sensor. <b>Off:</b> This function does not work. <b>Wake on LAN/MHL:</b> Enable the TV to be started by a signal over a LAN or MHL from another device.
	<b>Storage &amp; Reset:</b> View the memory usage status or perform a reset. When you perform a reset, the TV will be returned to the factory preset values, and the Google™ Accounts will also be deleted.	
	<b>About:</b> Check for system updates and view various information.	

Preference	<b>Date &amp; time:</b> Set the date and time.
	<b>Language:</b> You can select a language. Select from among 3 languages. (English, French and Spanish)
	<b>Keyboard:</b> Switch the keyboard setting.
	<b>Search:</b> Switch the Search function setting.
	<b>Speech:</b> Switch the Voice search setting.
	<b>Inputs:</b> Change the label for an input terminal, and switch between HDMI CEC control settings.
	<b>Accessibility:</b> Configure Caption, Talkback, and SwitchAccess settings. Some of the Caption settings may not be applied.
<b>Remote &amp; accessories</b>	<b>Add accessory:</b> Pair a Bluetooth device.
Personal	<b>Location:</b> Configure the location settings.
	<b>Security &amp; Restrictions:</b> Configure the security and restriction settings.
	<b>Add account:</b> Add an account.
<b>TV Setup</b>	<b>Jump to TV Setup:</b> Configure various TV Setup.

### NOTE

- The menu may be different depending on when you purchased the TV.

## Google Cast devices

When you connect a device such as a Google Cast-compatible smartphone or tablet to this TV, you can enjoy video and audio from the device on the TV's large screen and speakers.

- 1 Configure the settings from "HOME" > "Settings" > "Device" > "Google Cast".
- 2 Enable the Google Cast function on the Google Cast-compatible device and connect to the TV.  
(The TV screen changes according to the behavior of the device)

### NOTE

- When the TV is turned off or the connection is ended on the device, you must connect the device again.
- For details about the operation of the Google Cast-compatible device, check the manual for that device.

## Channels

## Full screen view

The applications and the channels will be displayed on the Channels full screen.

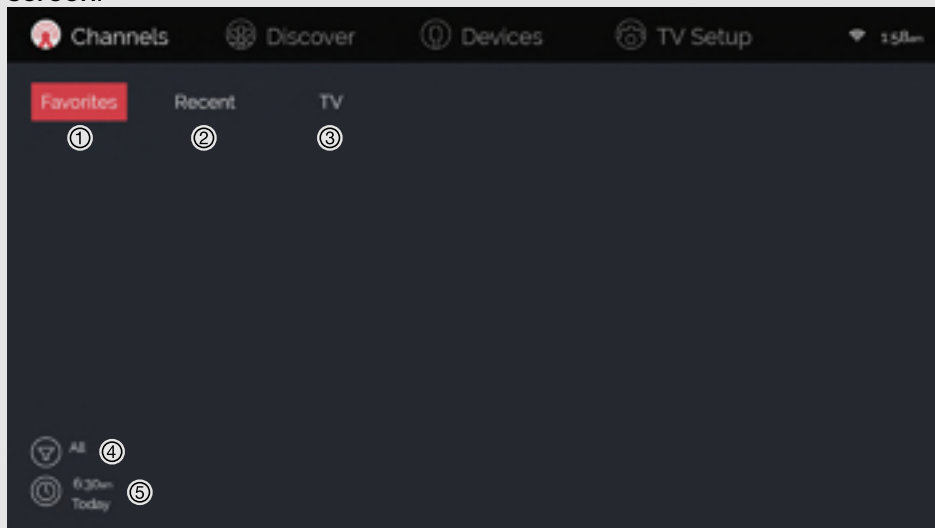

- ① Displays the applications and the channels registered as Favorites. [See page 3-36](#) for how to register a Favorite.
- ② Displays the channels and applications most recently selected from the Channels menu.
- ③ Displays programs currently being broadcast that match a selected genre or day/time for all channels.
- ④ Allows genre settings to be configured.
- ⑤ Allows a day/time to be selected.

## Peek screen view

The applications and the programs currently being broadcast by stations registered to the FAVORITE buttons on the remote control unit will be displayed on the Channels peek screen.

[See page 3-36](#) for how to assign the FAVORITE buttons on the remote control unit.

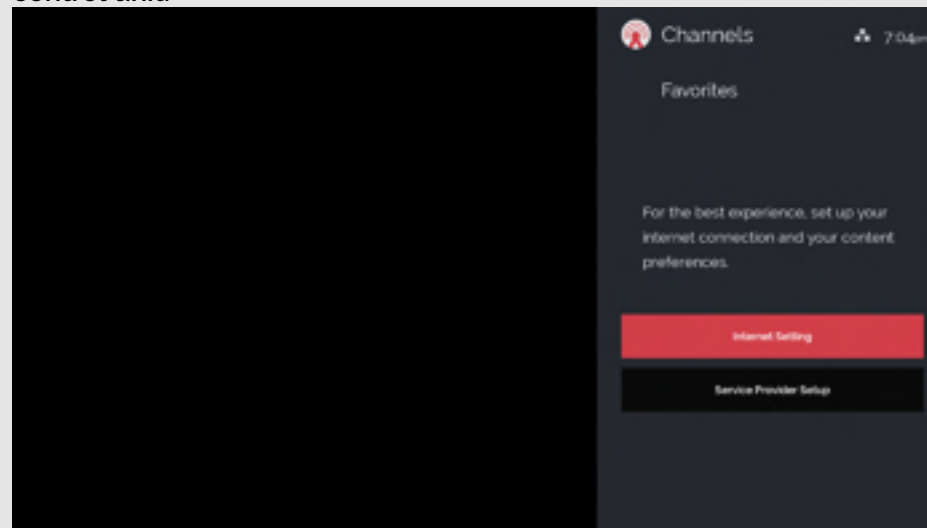

## NOTE

- To display the Channels in the full screen or as a peek screen, [see page 2-1](#).
- Changing from a full screen view to another mode is possible.

## Discover

## Full screen view

Recommended content and new content is displayed on the full screen of the Discover mode.

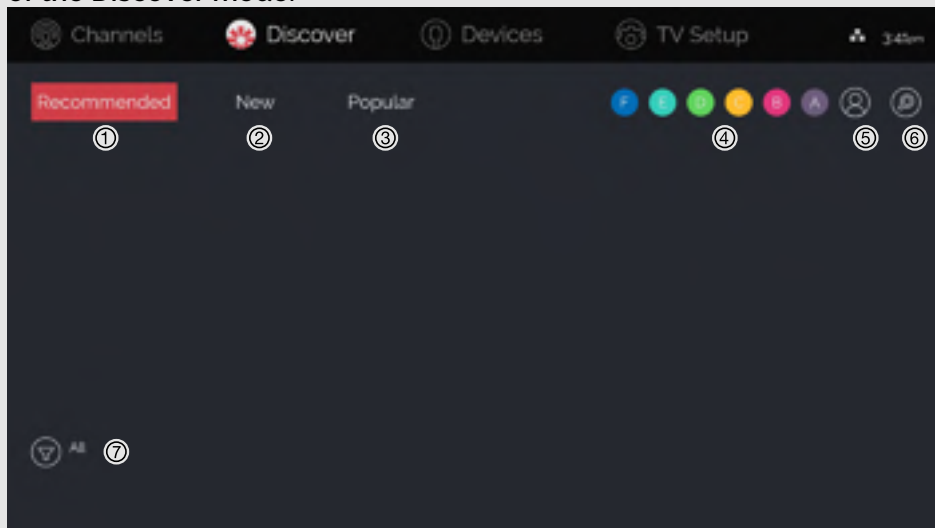



- ① Displays content recommended according to the currently logged in user.
- ② Displays new recommended content.
- ③ Displays popular recommended content.
- ④ Account mark of the logged in user
  - The mark is displayed in the color set when the account was made.
  - The characters are the initials of the name.
  - Up to six people can be logged in at the same time.
- ⑤ Displays the user login screen for Recommended and the setting screen for adding a new account.  
See the next explanation for details on logging in and account creation.
- ⑥ Allows for content searching.
- ⑦ Allows genre settings to be configured.

## NOTE

- If the accounts of six individuals have already been registered, you will have to delete an existing account.
- If you move away from the TV, we recommend that you log out.
- You will automatically be logged out when you turn the TV off.

## Account creation

Follow the procedure shown below to create an account.

- 1 Select , and then press ▼.
- 2 Select , and then press ● (ENTER) to display the Add account screen.
- 3 Enter the required information, select Complete, and then press ● (ENTER).

## Logging in

- 1 Select , and then press ▼.
- 2 Press ▲ / ▼ / ◀ / ▶ to select an account, and then press ● (ENTER).
  - If you set a PIN code during account creation, enter the PIN code.
- 3 Press ▲ / ▼ to select "Log In", and then press ● (ENTER).

## Account deletion

- 1 Select , and then press ▼.
- 2 Press ▲ / ▼ / ◀ / ▶ to select an account, and then press ● (ENTER).
  - If you are logged in, log out.
- 3 Press ▲ / ▼ to select "Delete", and then press ● (ENTER).

## Peek screen view

The content for the Recommended, New, and Popular tabs can be switched and displayed in the Discover peek screen.



- ⑧ Drop down to switch between tabs.

## NOTE

- To display the Discover in the full screen or as a peek screen, [see page 2-1](#).
- Changing from a full screen view to another mode is possible.

## Devices

### Full screen view

Switching between connected devices is possible on the Devices full screen.

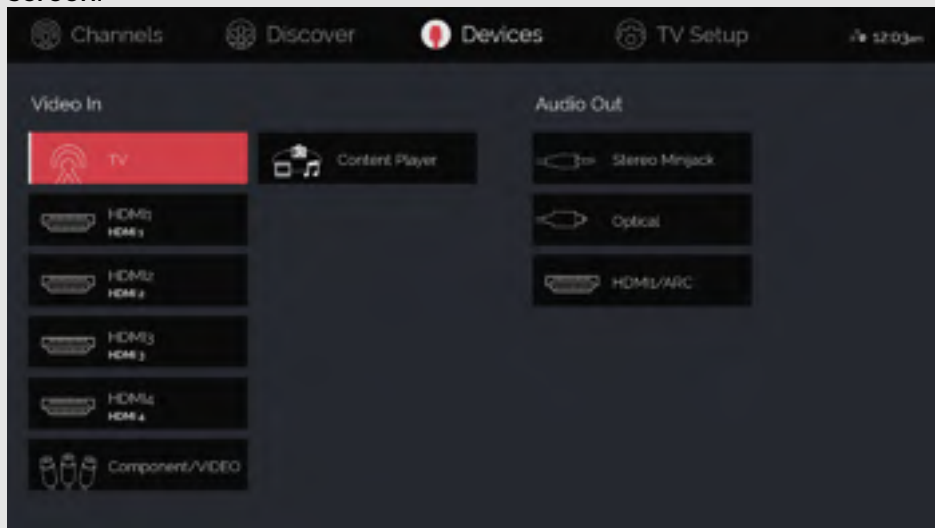

1. Press ▲ / ▼ / ◀ / ▶ to select the input source, and then press ● (ENTER).
  2. Press ▲ / ▼ to select the "Switch to Device", and then press ● (ENTER).
- An image from the selected source automatically displays.
  - If the target input is not connected, you will be able to switch to the input, but the correct video and audio will not be output. Be sure to connect the equipment beforehand.

### NOTE

- To display the Devices in the full screen or as a peek screen, [see page 2-1](#).
- Changing from a full screen view to another mode is possible.

### Peek screen view

The most commonly used input devices can be shown on the Devices peek screen.

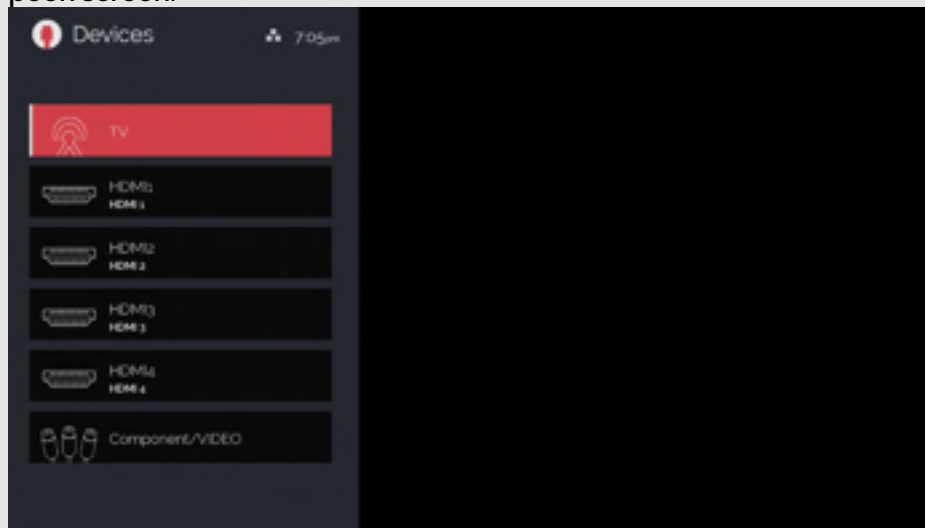

### Peek screen configuration

It is possible to configure which input devices to display on the peek screen.

Six devices are set by default.

To add a different device, first delete a current device, and then add the device.

- 1 Select the device in Devices full screen and open the Devices menu.
- 2 Set "Show in Peek" to "Yes".

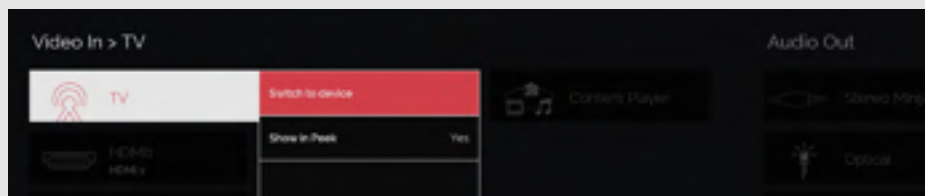

## TV Setup

## Full screen view

All menus for Picture, Audio, and General can be configured on the TV Setup full screen.



① Item displayed in red

- This indicates the item currently selected.
- Press ● (ENTER) to go to the adjustment screen for this item.

② This indicates the current setting for the item.

## Peek screen view

The AV Mode, View Mode, Surround, and Equalizer menus can be configured on the TV Setup peek screen.

See [pages 3-2](#), [3-26](#), [3-27](#), and [5-10](#) for details on the settings for each menu.

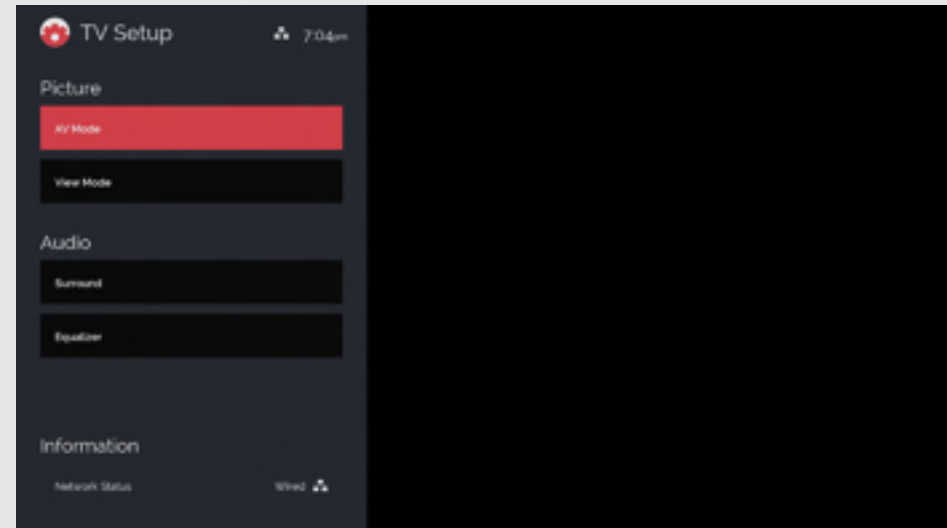

## NOTE

- To display the TV Setup in the full screen or as a peek screen, [see page 2-1](#).
- Changing from a full screen view to another mode is possible.



## Introduction

### About Menu Items

- Some menu items may not be displayed depending on the selected input source.

### NOTE

- The screens in the operation manual are for explanation purposes (some are enlarged, others cropped) and may vary slightly from the actual screens.
- The order of explanations for each menu item in the following pages is not necessarily in accordance with the alignment of the items on the screen.



## Example

Picture	
AV Mode	STANDARD
THX Setup	Dark Room
Automatic Light Sensor	On
Backlight	8
Contrast	32
Brightness	0
Color	8
Tint	0
Sharpness	2
Advanced	>>
Reset	

## Picture

## AV MODE (Changing Pic.Quality)

AV MODE gives you several viewing options to choose from to best match the surrounding environment of the TV, which can vary due to factors like room brightness, type of program watched or the type of device connected.

You can use USER Mode to create customized settings for each TV input. These settings will be automatically saved on each input for convenience.

**STANDARD:** For a highly defined image in a normal lighting.

**MOVIE:** For a movie.

**MOVIE THX:** Changes the image quality so that it conforms to the THX display standard.  
(For LC-70UH30U only.)

**GAME:** Lowers image brightness for easier viewing.

**PC:** For PC.

**USER:** Allows the user to customize settings as desired.

**DYNAMIC:** For a clear-cut image emphasizing high contrast, useful for sports viewing.

**DYNAMIC (Fixed):** Changes the image and sound settings to the factory preset values. No adjustments are allowed.

## NOTE

- You can select a different AV MODE item for each input mode. (For example, select STANDARD for TV input and DYNAMIC for COMPONENT.)
- When you play games, "GAME" is recommended for AV MODE.
- You can select AV MODE by pressing AV MODE on the remote control unit.



## Example

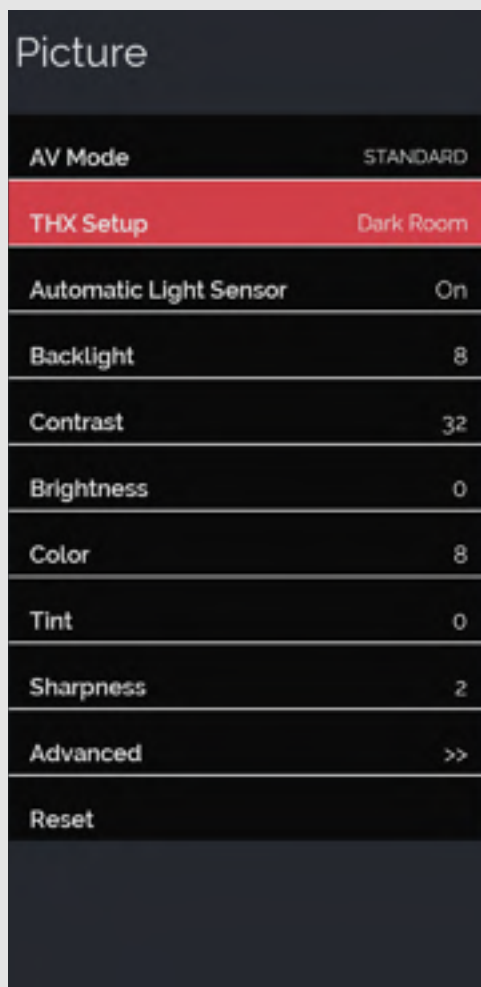

## Picture (Continue)

## THX Setup (For LC-70UH30U only)

Adjust the picture to room illumination or ambient brightness. This function is available only when AV MODE is set to "MOVIE THX".

**Bright room:** Select this item for a bright room.

**Dark room:** Select this item for a dark room.

## Example

Picture	
AV Mode	STANDARD
THX Setup	Dark Room
Automatic Light Sensor	On
Backlight	8
Contrast	32
Brightness	0
Color	8
Tint	0
Sharpness	2
Advanced	>>
Reset	

## Picture (Continue)

## Automatic Light Sensor (Light Sensor)

Automatically adjusts the brightness of the screen.

**Off:** The brightness is fixed at the value set in "Backlight".

**On:** Automatically adjusts.

## NOTE

- When set to "On", the Light Sensor senses the surrounding light and automatically adjusts the backlight brightness. Make sure nothing obstructs the Light Sensor, which could affect its ability to sense surrounding light.

## Example

Picture	
AV Mode	STANDARD
THX Setup	Dark Room
Automatic Light Sensor	On
Backlight	8
Contrast	32
Brightness	0
Color	8
Tint	0
Sharpness	2
Advanced	>>
Reset	

## Picture (Continue)

## Backlight

Adjusts the picture to your preference with the following picture settings.

Selected item	◀ button	▶ button
Backlight	The screen dims	The screen brightens

- For resetting all Picture adjustment items to the factory preset values, press ▲ / ▼ to select "Reset", press ● (ENTER), press ▲ / ▼ to select "Yes", and then press ● (ENTER)

## NOTE

- "Backlight" is not available when you set Automatic Light Sensor to "On".

## Example

Picture	
AV Mode	STANDARD
THX Setup	Dark Room
Automatic Light Sensor	On
Backlight	8
Contrast	32
Brightness	0
Color	8
Tint	0
Sharpness	2
Advanced	>>
Reset	

## Picture (Continue)

## Contrast

Adjusts the picture to your preference with the following picture settings.

Selected item	◀ button	▶ button
Contrast	For less contrast	For more contrast

- For resetting all Picture adjustment items to the factory preset values, press ▲ / ▼ to select "Reset", press ● (ENTER), press ▲ / ▼ to select "Yes", and then press ● (ENTER)

## Example

Picture	
AV Mode	STANDARD
THX Setup	Dark Room
Automatic Light Sensor	On
Backlight	8
Contrast	32
<b>Brightness</b>	<b>0</b>
Color	8
Tint	0
Sharpness	2
Advanced	>>
Reset	

## Picture (Continue)

## Brightness

Adjusts the picture to your preference with the following picture settings.

Selected item	◀ button	▶ button
Brightness	For less brightness	For more brightness

- For resetting all Picture adjustment items to the factory preset values, press ▲ / ▼ to select "Reset", press ● (ENTER), press ▲ / ▼ to select "Yes", and then press ● (ENTER)

## Example

Picture	
AV Mode	STANDARD
THX Setup	Dark Room
Automatic Light Sensor	On
Backlight	8
Contrast	32
Brightness	0
<b>Color</b>	<b>8</b>
Tint	0
Sharpness	2
Advanced	>>
Reset	

## Picture (Continue)

## Color

Adjusts the picture to your preference with the following picture settings.

Selected item	◀ button	▶ button
Color	For less color intensity	For more color intensity

- For resetting all Picture adjustment items to the factory preset values, press ▲ / ▼ to select "Reset", press ● (ENTER), press ▲ / ▼ to select "Yes", and then press ● (ENTER)

## NOTE

- "Color" is not available when you set AV MODE to "PC".

## Example

Picture	
AV Mode	STANDARD
THX Setup	Dark Room
Automatic Light Sensor	On
Backlight	8
Contrast	32
Brightness	0
Color	8
Tint	0
Sharpness	2
Advanced	>>
Reset	

## Picture (Continue)

## Tint

Adjusts the picture to your preference with the following picture settings.

Selected item	◀ button	▶ button
Tint	Skin tones become reddish	Skin tones become greenish

- For resetting all Picture adjustment items to the factory preset values, press ▲ / ▼ to select "Reset", press ● (ENTER), press ▲ / ▼ to select "Yes", and then press ● (ENTER)

## NOTE

- "Tint" is not available when you set AV MODE to "PC".

## Example

Picture	
AV Mode	STANDARD
THX Setup	Dark Room
Automatic Light Sensor	On
Backlight	8
Contrast	32
Brightness	0
Color	8
Tint	0
Sharpness	2
Advanced	>>
Reset	

## Picture (Continue)

## Sharpness

Adjusts the picture to your preference with the following picture settings.

Selected item	◀ button	▶ button
Sharpness	For less sharpness	For more sharpness

- For resetting all Picture adjustment items to the factory preset values, press ▲ / ▼ to select "Reset", press ● (ENTER), press ▲ / ▼ to select "Yes", and then press ● (ENTER)
- For resetting all Picture adjustment items to the factory preset values, press ▲ / ▼ to select "Reset", press ● (ENTER), press ▲ / ▼ to select "Yes", and then press ● (ENTER)

## NOTE

- "Sharpness" is not available when you set AV MODE to "PC".



## Example

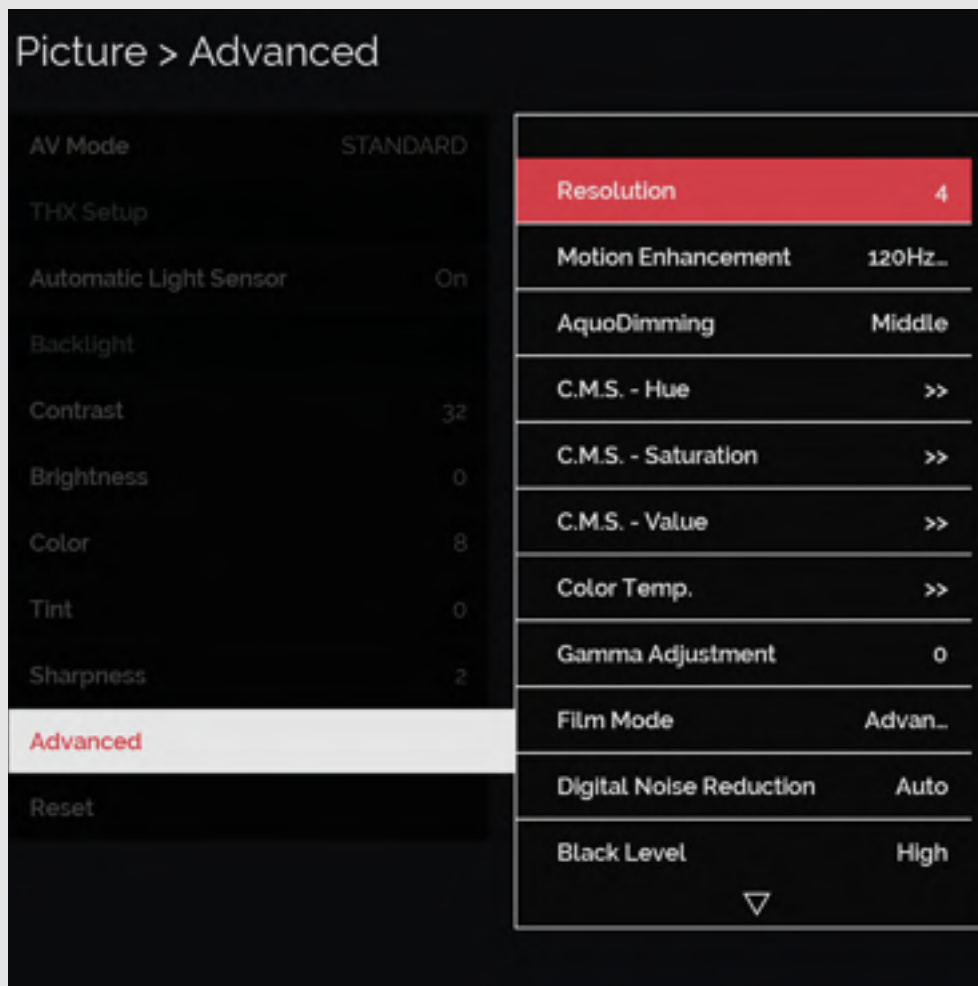

## Picture (Continue)

Advanced

Resolution

The fineness can be adjusted in the range of 0 to +10.

## NOTE

- "Resolution" is not available when you set AV MODE to "PC".

## Example

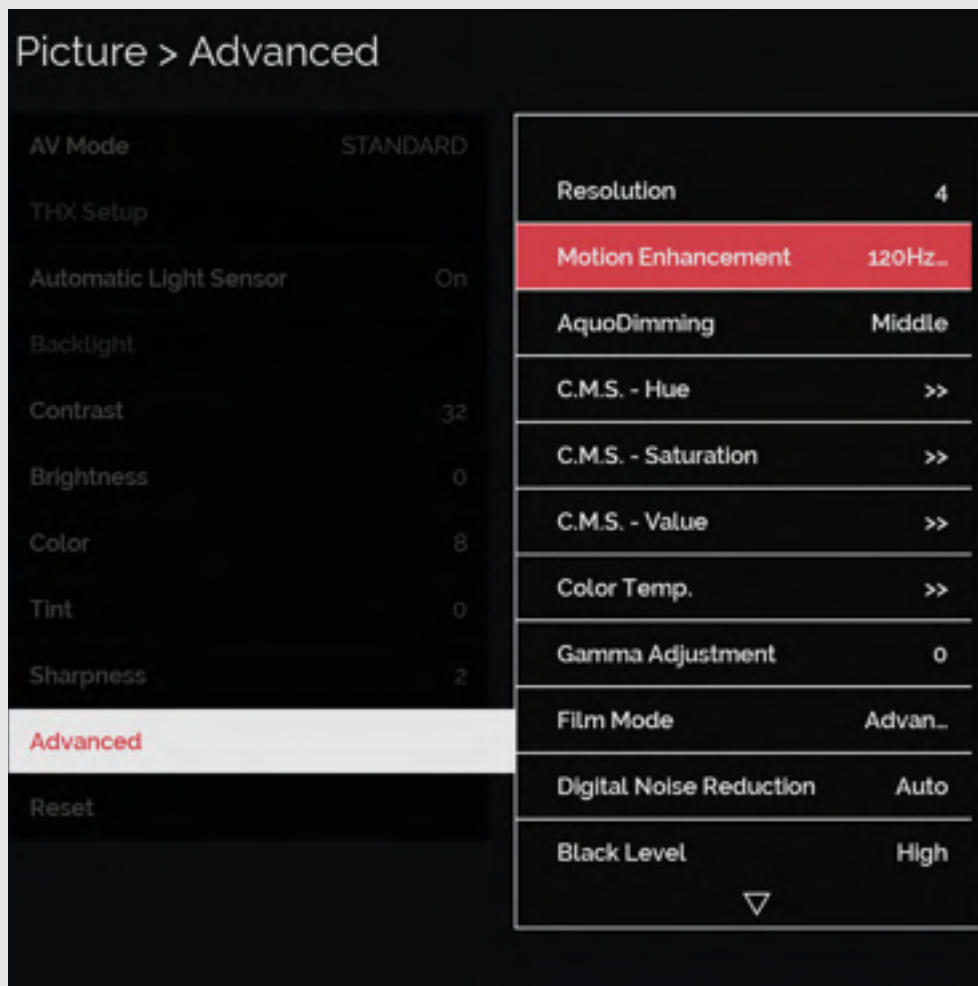

## Picture (Continue)

Advanced

## Motion Enhancement

Use Motion Enhancement to view fast-action video more clearly.

Selected item	Description
AquoMotion960	Turn the LED backlight on or off for 120Hz drive display.
AquoMotion480	
120Hz High	For obtaining a clearer image.
120Hz Low	
Off	Original image.

## ■UH30U model

AquoMotion960/ 120Hz High/ 120Hz Low/ Off

## ■UE30U and UC30U model

AquoMotion480/ 120Hz High/ 120Hz Low/ Off

## NOTE

- "Motion Enhancement" may cause image noise. If this occurs, turn the function "Off".
- When AV MODE is set to "GAME" or "PC", or PC format is being input, "Motion Enhancement" is not available.
- When Film Mode is set to "Standard", "Motion Enhancement" is not available.

## Example

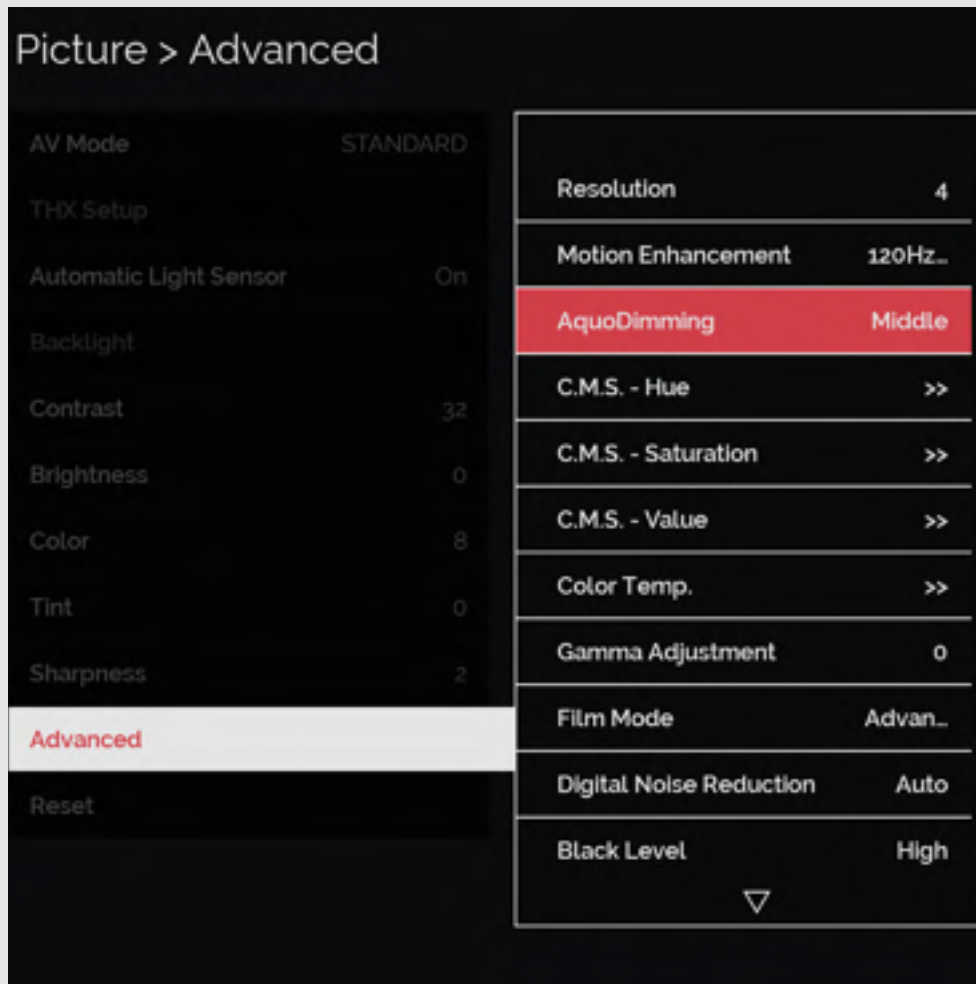

## Picture (Continue)

Advanced

AquoDimming

Fine brightness control can be used to adjust the contrast between the light and shadow of the image.

High/Middle/Low/Off

## Example

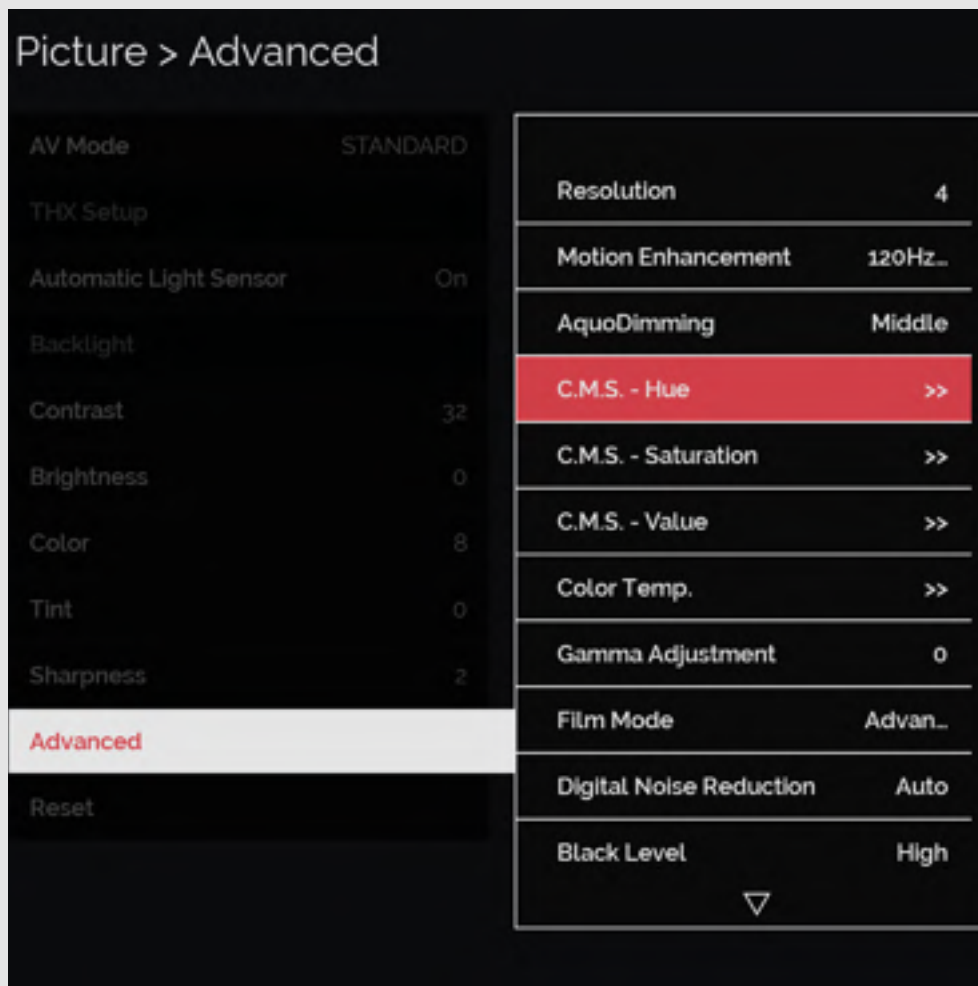

## Picture (Continue)

## Advanced

## C.M.S. (Color Management System)

Color tone is managed using the six-color adjustment setting.

**C.M.S.-Hue:** This is a standard to adjust the color either more reddish or more bluish in tone.

A lower value makes the image darker.

## NOTE

- For resetting all adjustment items to the factory preset values, press ▲ / ▼ to select "Reset", and then press ● (ENTER).
- "C.M.S.-Hue" is not available when you set AV MODE to "PC".

## Example

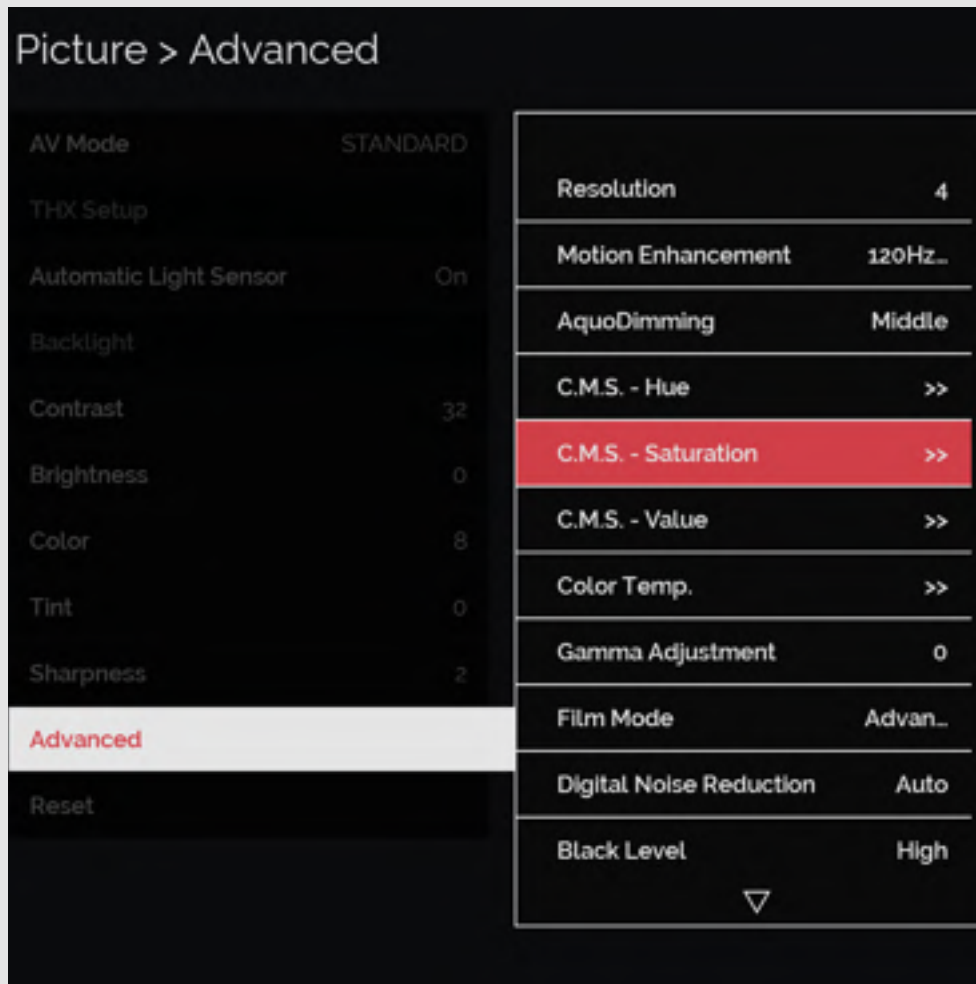

## Picture (Continue)

## Advanced

## C.M.S. (Color Management System)

Color tone is managed using the six-color adjustment setting.

**C.M.S.-Saturation:** Increases or decreases the saturation of a selected color.

A lower value makes the image darker.

## NOTE

- For resetting all adjustment items to the factory preset values, press ▲ / ▼ to select "Reset", and then press ● (ENTER).
- "C.M.S.-Saturation" is not available when you set AV MODE to "PC".

## Example

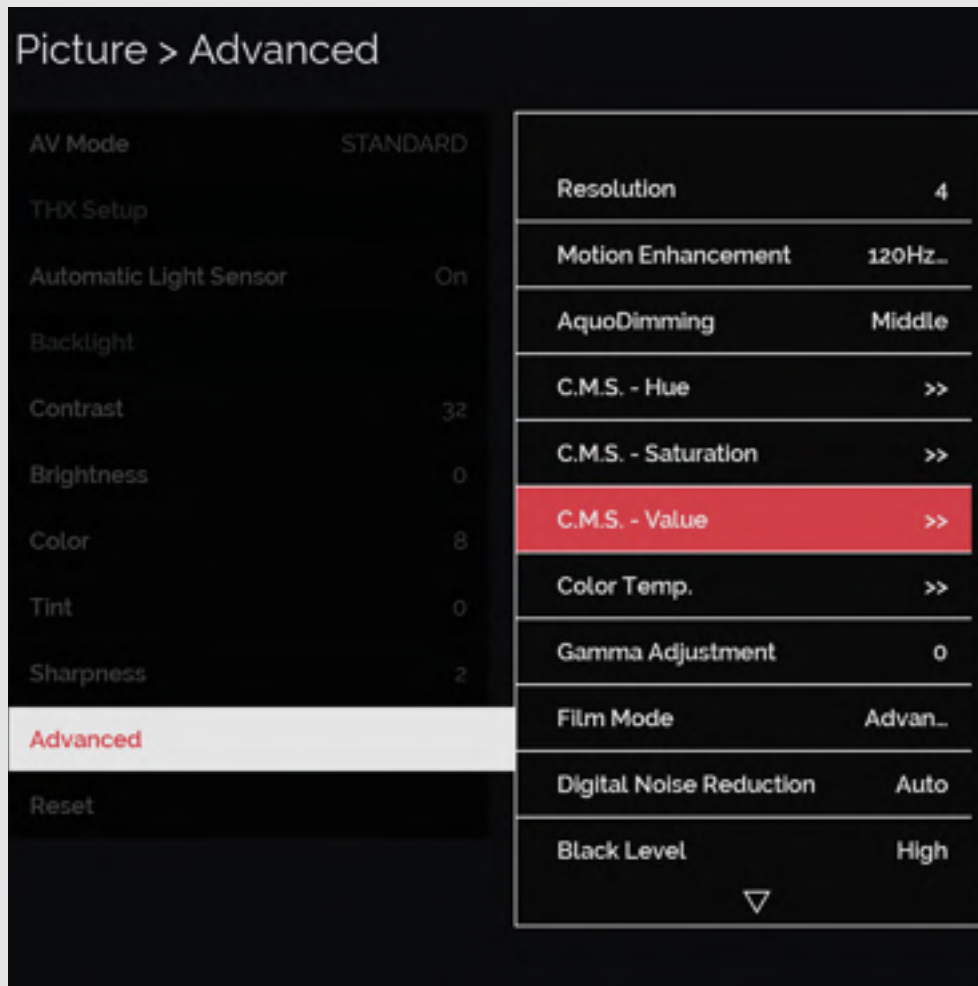

## Picture (Continue)

## Advanced

## C.M.S. (Color Management System)

Color tone is managed using the six-color adjustment setting.

**C.M.S.-Value:** A higher value makes the image brighter.

A lower value makes the image darker.

## NOTE

- For resetting all adjustment items to the factory preset values, press ▲ / ▼ to select "Reset", and then press ● (ENTER).
- "C.M.S.-Value" is not available when you set AV MODE to "PC".

### Example

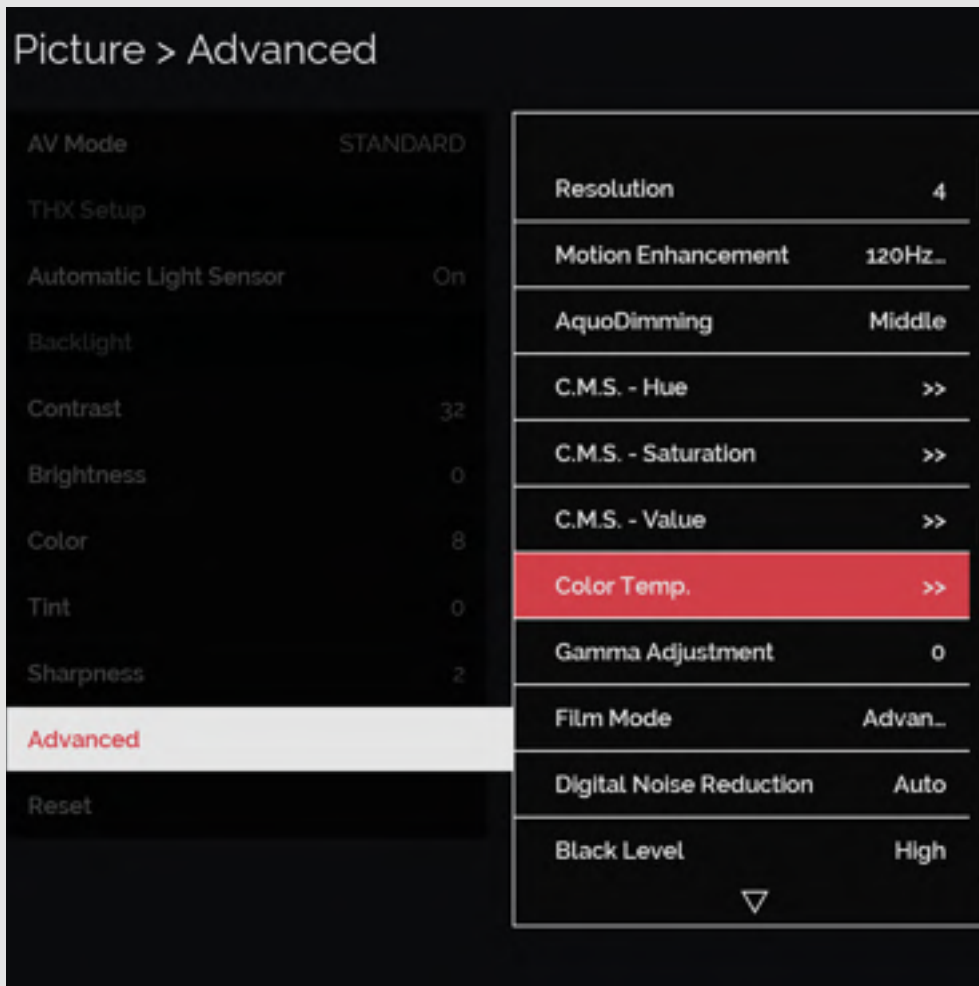

## Picture (Continue)

### Advanced

### Color Temp. (Color Temperature)

For a better white balance, use color temperature correction.

**High:** White with bluish tone

**Mid-High:**

**Middle:**

**Mid-Low:**

**Low:** White with reddish tone



White balance can be adjusted between a maximum of +30 and a minimum of -30 for each color temperature.

### R Gain/G Gain/B Gain

### Fine tuning the color temperature

You can adjust the "10 Point Setting" setting. Adjust the set color temperature from +1 to +10.

White balance can be adjusted between a maximum of +30 and a minimum of -30 for each color temperature.

### NOTE

- When "10 Point Setting" is set to "10", you can adjust the white balance between -30 and 0.
- For resetting all adjustment items to the factory preset values, press ▲ / ▼ to select "Reset", and then press ● (ENTER).

## Example

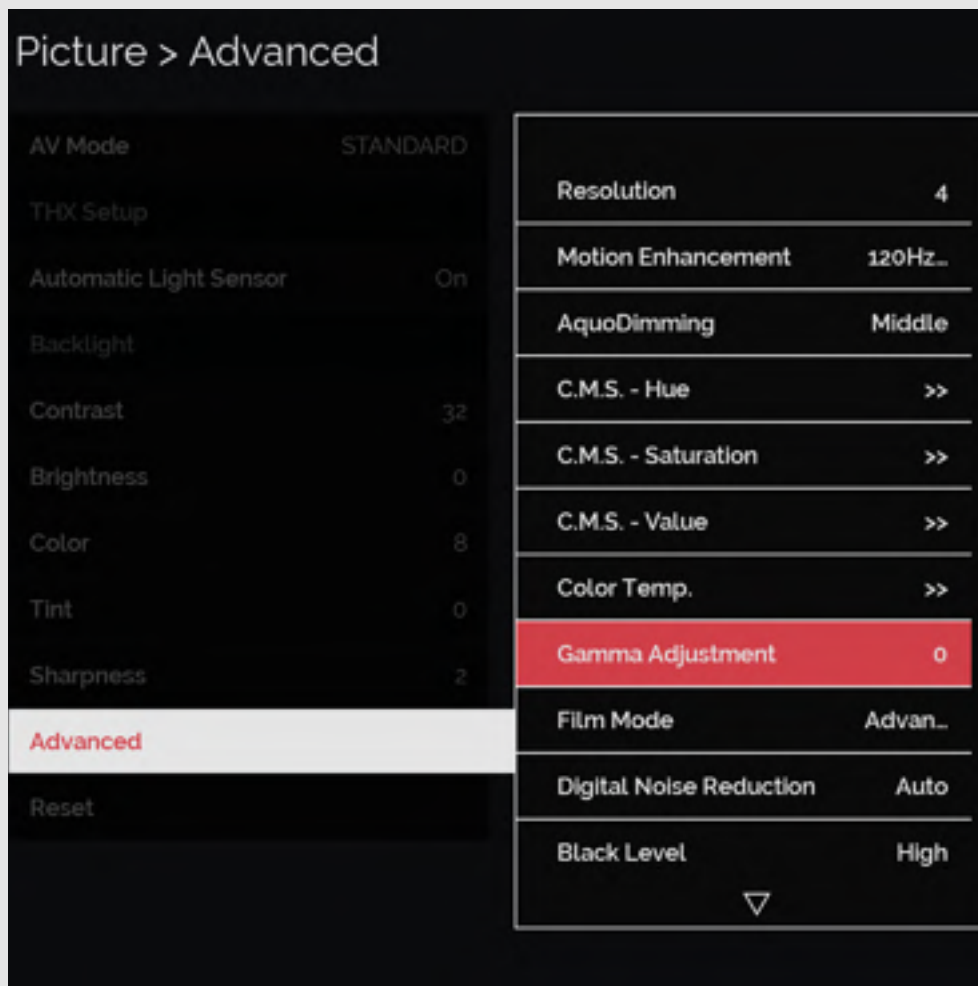

## Picture (Continue)

## Advanced

## Gamma Adjustment

Adjusts the differences of picture tones between bright parts and dark parts. The adjustment range of the gamma can be set to a maximum of +3 and a minimum of -3 by pressing ◀ or ▶.



## Example

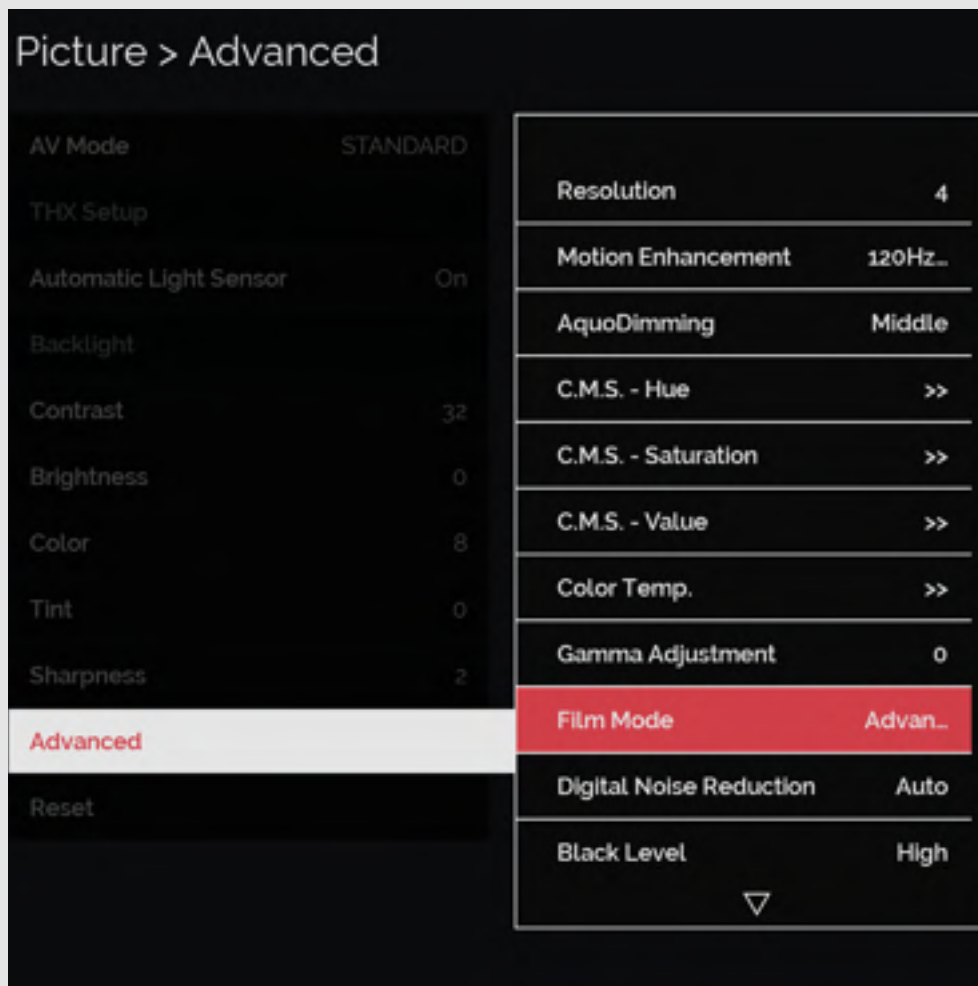

## Picture (Continue)

Advanced

## Film Mode (3:2 pull-down)

This function provides high-quality playback of images originally encoded at 24 frames/second, such as films.

**Advanced High:** Provides smoother image motion while ensuring high-quality playback.

**Advanced Mid:** Adjusts effect to reduce judder at a level above "Advanced Low".

**Advanced Low:** Adjusts effect to reduce judder from film contents.

**Standard:** Plays back images with equal display time for each frame, reproducing movie theater experience.

**Off:** Normal viewing mode.

## NOTE

- "Film Mode" does not function depending on input signal type.
- "Film Mode" does not function when you set AV MODE to "GAME" or "PC".

## Example

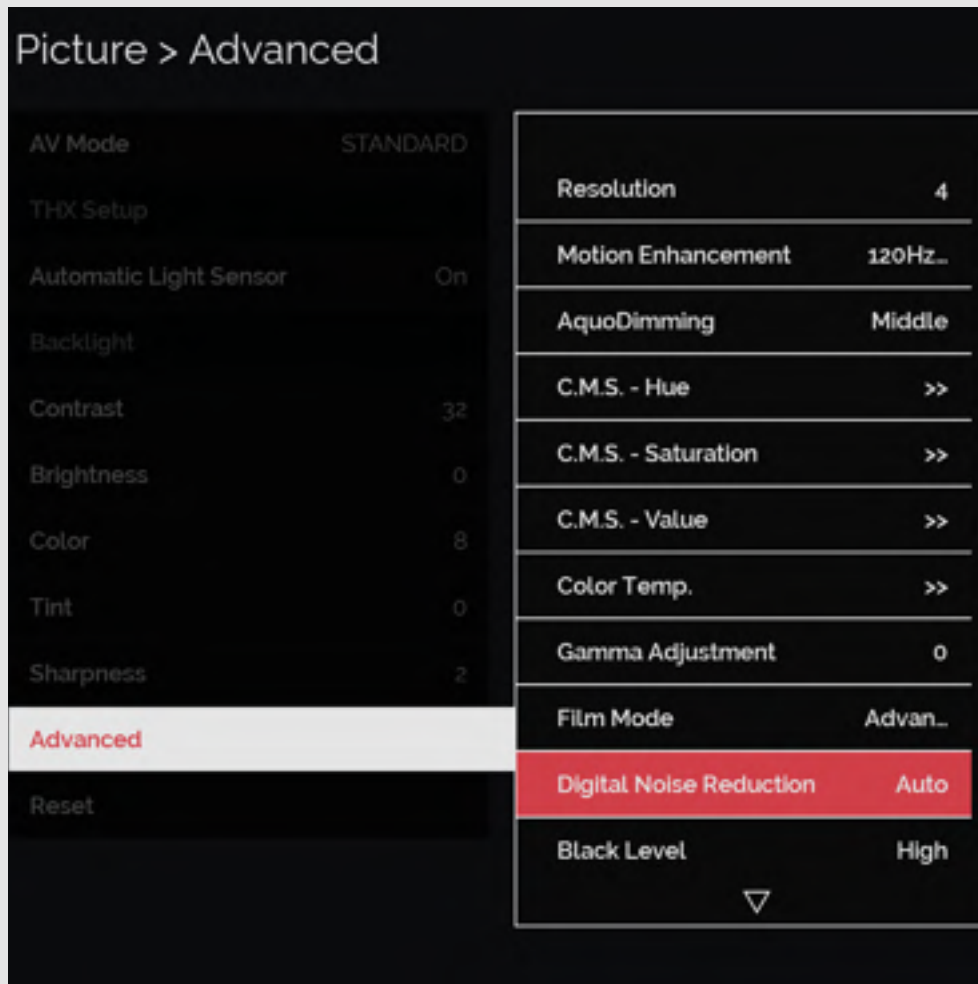

## Picture (Continue)

## Advanced

## Digital Noise Reduction

Produces a clearer video image.

**Auto:** Automatically adjusts the level of noise reduction.

**High/Middle/Low:** You can select a desired level for viewing a clearer video image.

**Off:** No adjustment.

## NOTE

- "Digital Noise Reduction" is not available when you set AV MODE to "PC" or PC format is being input.

## Example

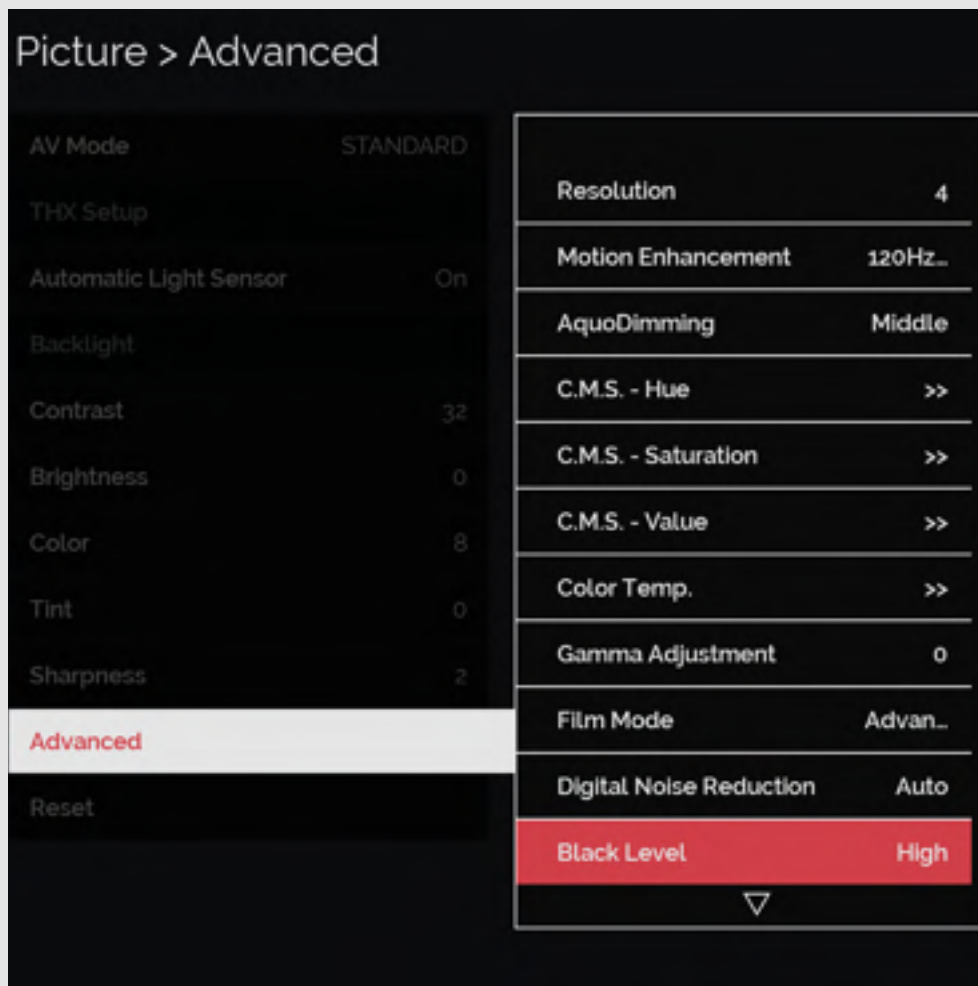

## Picture (Continue)

Advanced

Black Level

Adjusts on-screen black level to your preferred level.

**High:** The black level gets brighter.

**Low:** The black level gets darker.

## NOTE

- "Black Level" is available for input signal from Composite Video and analog broadcasts (air and cable).

## Example

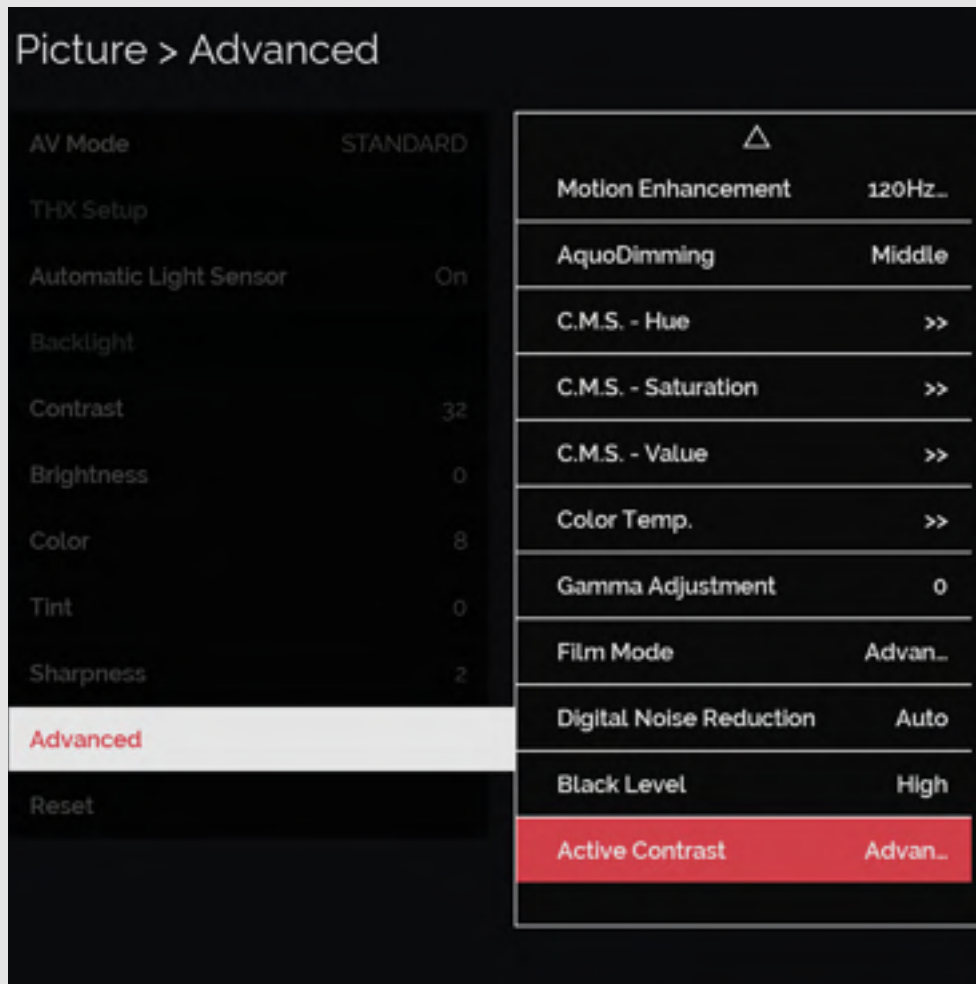

## Picture (Continue)

Advanced

## Active Contrast

Automatically adjusts the image contrast according to the scene.

**Advanced:** Produces higher contrast image in any scene.

**Standard:** Produces high contrast image in bright scene.

**Off:** No adjustment.

## NOTE

- "Active Contrast" is not available when you set AV MODE to "PC".

## Example

Picture	
AV Mode	STANDARD
THX Setup	Dark Room
Automatic Light Sensor	On
Backlight	8
Contrast	32
Brightness	0
Color	8
Tint	0
Sharpness	2
Advanced	>>
Reset	

## Picture (Continue)

## Reset

Returns Picture Settings to their factory preset values. To reset, select "YES" and then press ● (ENTER).

## Example

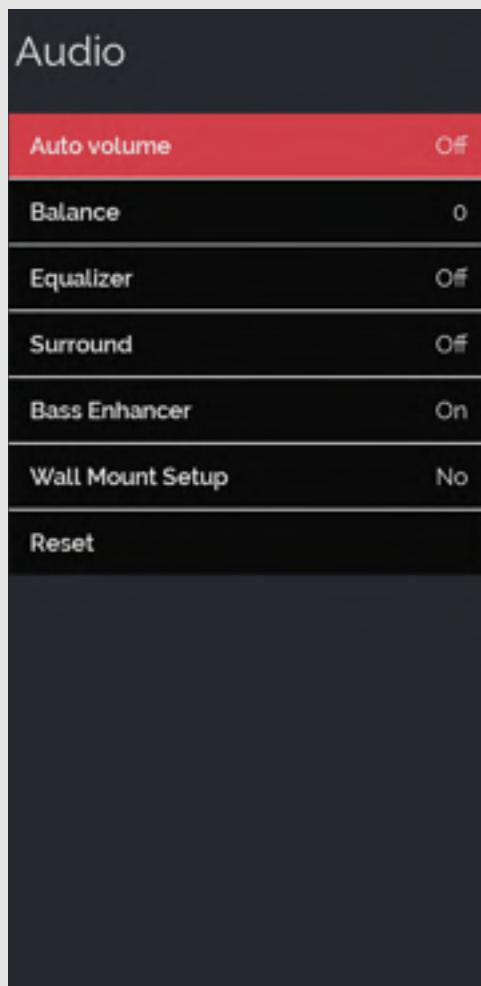

## Audio

## Auto volume

Different sound sources sometimes do not have the same loudness level, such as a program and its commercial breaks. The Automatic Volume Control (Auto Volume) reduces this problem by equalizing.

**ON:** Reduces the loudness gaps among different sound source. The result is automatically adjusted according to the sound sources.

**OFF:** No adjustment.

## NOTE

- The Audio menu is grayed out when "Output Select" is set to "Variable".  
[\(See page 4-4.\)](#)

## Example

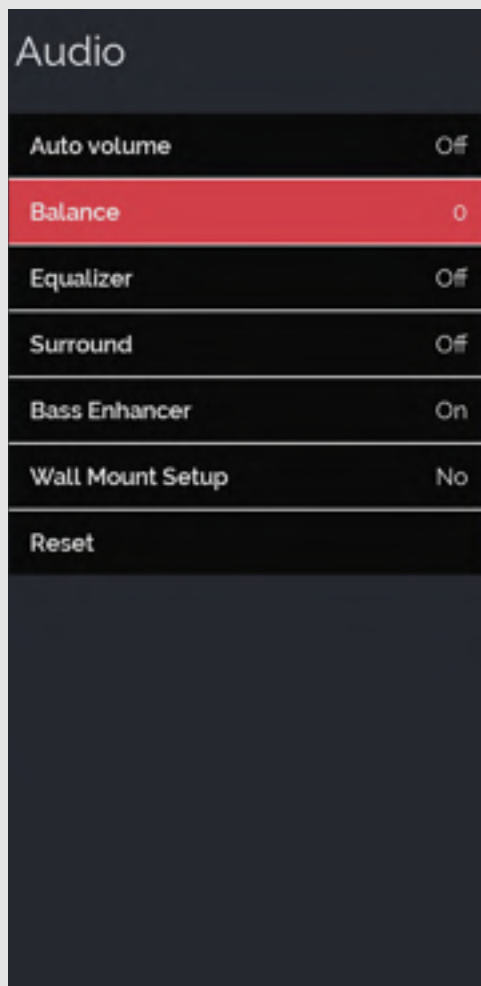

## Audio (Continue)

## Balance

You can adjust the sound quality to your preference with the following settings.

Selected item	◀ button	▶ button
Balance	Decrease audio from the right speaker	Decrease audio from the left speaker

## NOTE

- The Audio menu is grayed out when "Output Select" is set to "Variable".  
(See [page 4-4.](#))
- For resetting Audio adjustment items to the factory preset values, press ▲ / ▼ to select "Reset", press ● (ENTER), press ▲ / ▼ to select "Yes", and then press ● (ENTER).

## Example

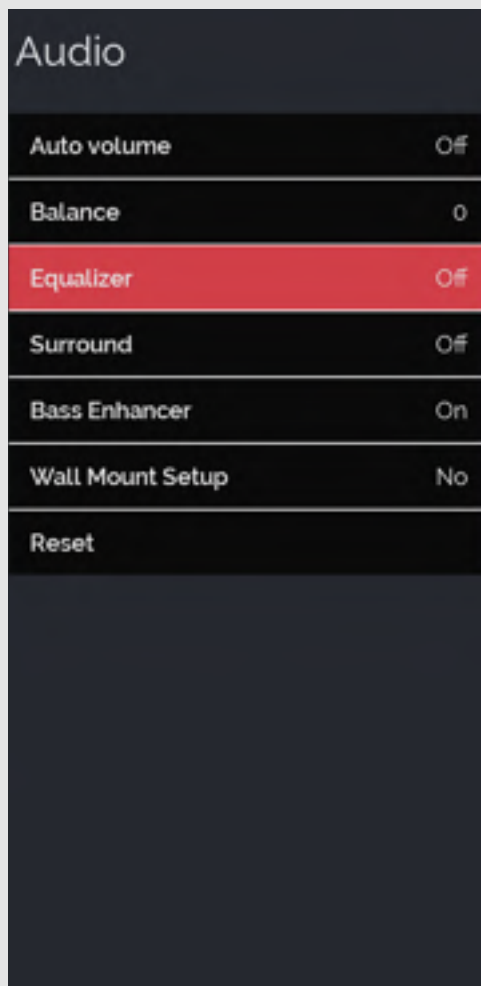

## Audio (Continue)

## Equalizer

This function allows you to change the sound quality.

Select from the following available settings.

**Rock/Pop/Live/Dance/Techno/Classic/  
Soft/Off**

## NOTE

- The Audio menu is grayed out when "Output Select" is set to "Variable".  
[\(See page 4-4.\)](#)



## Example

Audio	
Auto volume	Off
Balance	0
Equalizer	Off
Surround	Off
Bass Enhancer	On
Wall Mount Setup	No
Reset	

## Audio (Continue)

## Surround

The surround function produces Surround effect from the speakers.

## NOTE

- The Audio menu is grayed out when "Output Select" is set to "Variable".  
[\(See page 4-4.\)](#)
- For some discs, setup may be required on your BD/DVD player. In this case, please refer to the operation manual of your BD/DVD player.

## Example

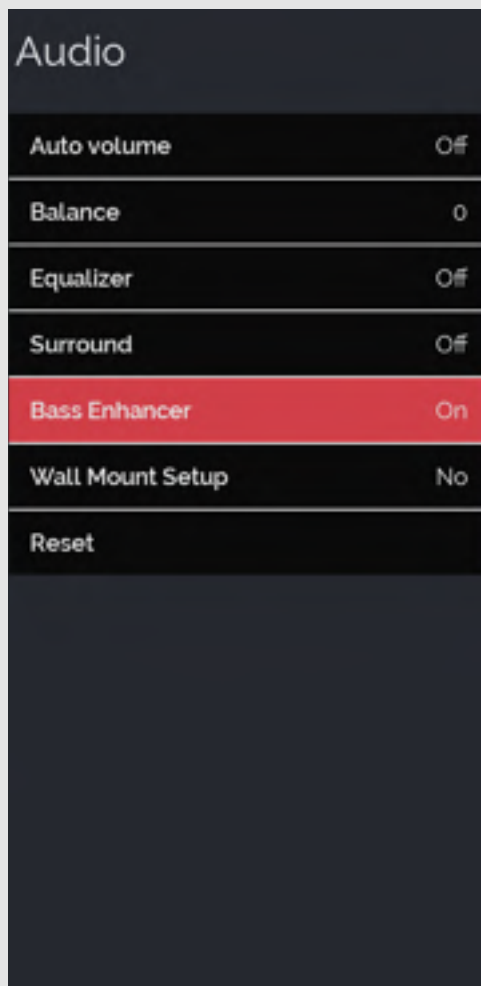

## Audio (Continue)

## Bass Enhancer

This function improves the sound quality. The low range will be extended and the sounds in the medium and high ranges, which have been lost due to the data being compressed, will be restored.

This setting is effective when playing back audio through a wireless interface such as when using Bluetooth playback.

## NOTE

- The Audio menu is grayed out when "Output Select" is set to "Variable".  
[\(See page 4-4.\)](#)

## Example

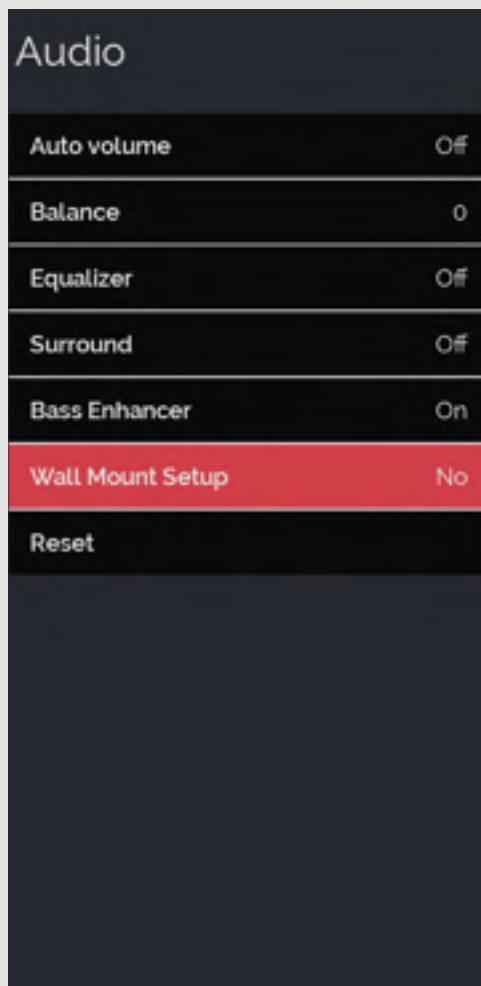

## Audio (Continue)

## Wall Mount Setup

This selects the optimal audio for the program you are currently watching even when the TV is mounted to a wall.

## Example

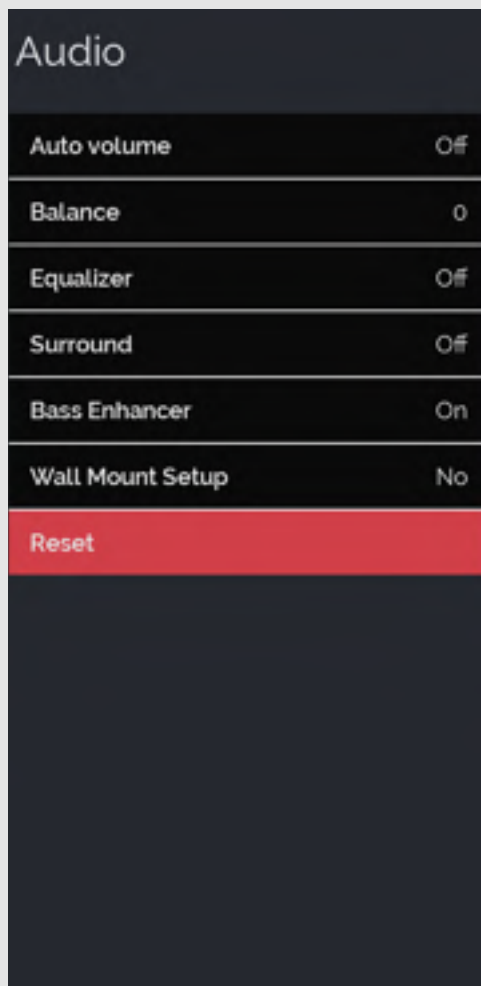

## Audio (Continue)

## Reset

Returns Audio Settings to their factory preset values. To reset, select "YES" and then press ● (ENTER).

## NOTE

- The Audio menu is grayed out when "Output Select" is set to "Variable".  
[\(See page 4-4.\)](#)

## Example

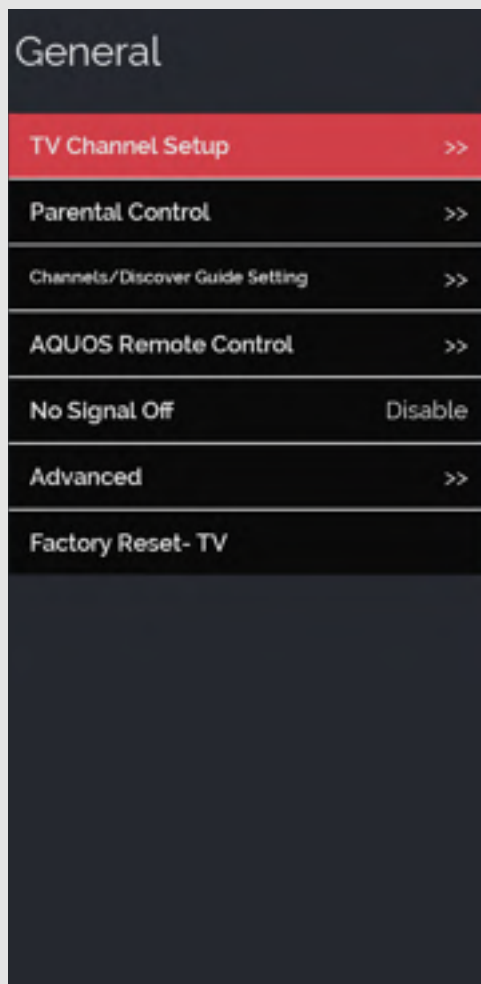

## General

## TV Channel Setup

## CH Setup

If Initial Installation does not memorize all the channels in your region, follow the instructions below to manually memorize the channels.

**Air/Cable:** Make sure what kind of connection is made with your TV when selecting "Air" or "Cable".

**CH Search:** Channel auto search makes the TV look for all channels viewable in the set area.

**CH Memory:** You can select the channels to skip.

## NOTE

- If no channel is found, confirm the type of connection made with your TV and try channel search again.
- This function will not be selectable from the menu if you do not first configure your secret number. (Default: 1234)

## Antenna Setup-DIGITAL

In order to receive digital air broadcasts, you need a digital broadcast antenna. You can confirm the antenna configuration through the "Antenna Setup-DIGITAL" screen. If necessary, adjust the direction of the antenna to obtain the maximum signal strength.

**Signal Strength:** The signal strength of DIGITAL channel is displayed. The signal information is based on the current channel.

## Example

## General (Continue)

Parental Control  
(Parental Control Setting)

## Parental Control

Used to enable or disable the parental control function. This function will not be selectable from the menu if you do not first configure your secret number. (Default: 1234)

## Rating (US/CA)

## V-CHIP

V-CHIP is an electronic filtering device built into your TV. This tool gives parents a great degree of control over broadcasts accessed by their children. It allows parents to select programs judged suitable for child viewing while blocking ones judged not suitable. It does so automatically once you activate the V-CHIP feature in your TV. "V-Chip" will not be selectable from the menu if you do not first configure your secret number.

- The U.S. has two rating systems for viewing content: TV Parental Guidelines and movie ratings.
- The TV Parental Guidelines work in conjunction with the V-CHIP to help parents screen out inappropriate television shows from their children.
- Movie ratings are used for original movies rated by the Motion Picture Association of America (MPAA) as watched on cable TV and not edited for television. The V-CHIP can also be set to block MPAA-rated movies.

## NOTE

- The setting automatically enters "Block" for any ratings below your selection.

## MPAA

## Example

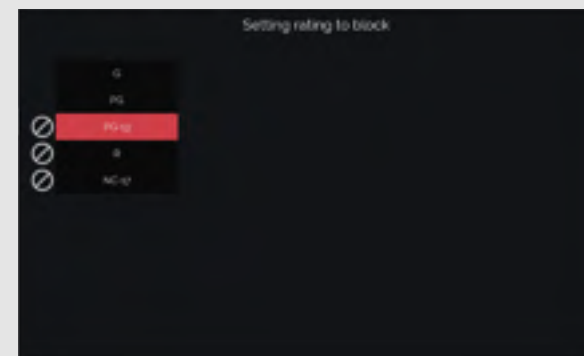

Press ▲ / ▼ to adjust the item to your desired position, and press ● (ENTER).

"⊘" indicates the item is blocked.

G: General audiences. All ages admitted.

PG: Parental guidance suggested. Some material may not be suitable for children.

PG-13: Parents strongly cautioned. Some material may be inappropriate for children under 13.

R: Restricted. Under 17 requires accompanying parent or adult guardian (age varies in some jurisdictions).

NC-17: No one 17 and under admitted.

## NOTE

- Voluntary movie rating system only uses an age-based rating.

Example

## General (Continue)

### Parental Control (Parental Control Setting)

TV Guidelines

Example



### Suggested age

- TV-Y: All children.
- TV-Y7: Directed to older children.
- TV-G: General audience.
- TV-PG: Parental Guidance suggested.
- TV-14: Parents strongly cautioned.
- TV-MA: Mature audience only.

#### When setting an individual content-based rating item:

- 1 Press **▶** to access content items without blocking the currently selected age-based rating item.
- 2 Press **◀/▶** to select an individual item, and then press **●** (ENTER) to block it (" " is added to the content-based rating item, and " " is added to the age-based rating item).
- 3 Repeat the same steps for the other items.

Content  
 FV: Fantasy violence.  
 V: Violence.  
 S: Sexual situation.  
 L: Adult language.  
 D: Sexually suggestive dialog.

Rating	Content				
	FV	V	S	L	D
Suggested age	TV-Y				
	TV-Y7	X			
	TV-G				
	TV-PG		X	X	X
	TV-14		X	X	X
	TV-MA		X	X	X

X : Content rating can be set.  
 When you unblock a content item, also unblock the main rating item.

### Canadian Rating Systems (Canadian English ratings and Canadian French ratings)

- The TV rating systems in Canada are based on the Canadian Radio-Television and Telecommunications Commission (CRTC) policy on violence in television programming.
- While violence is the most important content element to be rated, the structure developed takes into consideration other program content like language, nudity, sexuality and mature themes.
- When setting the V-CHIP on the Canadian system you can choose either the Canadian English ratings or the Canadian French ratings.

## Example

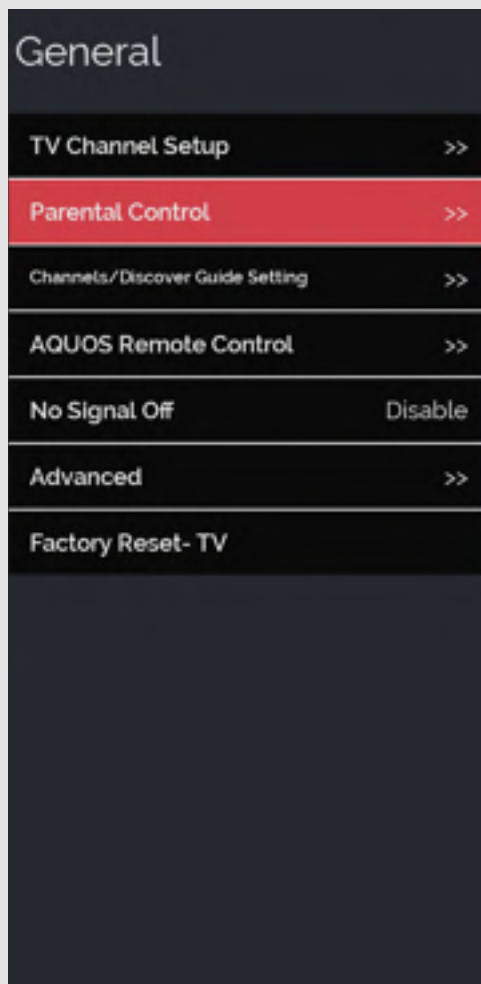

## General (Continue)

Parental Control  
(Parental Control Setting)

## Can.English Ratings

- E:** Exempt: Includes news, sports, documentaries and other information programming; talk shows, music videos, and variety programming.
- C:** Children: Intended for younger children under the age of 8 years. Pays careful attention to themes that could threaten their sense of security and well-being.
- C8\*:** Children over 8 years old: Contains no portrayal of violence as the preferred, acceptable, or only way to resolve conflict; nor encourage children to imitate dangerous acts which they may see on the screen.
- G:** General: Considered acceptable for all age groups. Appropriate viewing for the entire family, contains very little violence, physical, verbal or emotional.
- PG:** Parental Guidance: Intended for a general audience, but may not be suitable for younger children (under the age of 8) because it could contain controversial themes or issues.
- 14\*:** Over 14 years: Could contain themes where violence is one of the dominant elements of the storyline, but it must be integral to the development of plot or character. Language usage could be profane and nudity present within the context of the theme.
- 18\*:** Adults: Intended for viewers 18 years and older and might contain depictions of violence, which while related to the development of plot, character or themes, are intended for adult viewing. Could contain graphic language and portrayals of sex and nudity.

## Can.French Ratings

- E:** Exempt programming.
- G:** General: All ages and children, contains minimal direct violence, but may be integrated into the plot in a humorous or unrealistic manner.
- 8ans\*:** General but inadvisable for young children: May be viewed by a wide public audience, but could contain scenes disturbing to children under 8 who cannot distinguish between imaginary and real situations.
- Recommended for viewing with parent.
- 13ans\*:** Over 13 years: Could contain scenes of frequent violent scenes and therefore recommended for viewing with parent.
- 16ans\*:** Over 16 years: Could contain frequent violent scenes and intense violence.
- 18ans\*:** Over 18 years: Only for adult viewing. Could contain frequent violent scenes and extreme violence.

## How to temporarily release the V-CHIP BLOCK

When the V-CHIP BLOCK is working and censors a broadcast, "V-CHIP HAS BEEN ACTIVATED." displays.

- 1 Press **ENTER** while the V-CHIP is working, and then the secret number setting menu displays.
- 2 Input the 4-digit secret number by using software keyboard. At this time V-CHIP BLOCK temporarily releases.

## Rating (Other)

This is used in countries other than the United States and Canada.



Example

**General (Continue)****Parental Control  
(Parental Control Setting)****IMPORTANT:**

Two conditions must be met to enable the V-Chip (see pages [3-32 to 3-34](#) and [3-40](#)):

1. Secret No. is registered.
2. V-Chip/V-Chip (DTV Only) settings have been made.
  - The "V-Chip (DTV Only)" will only be selectable when a new rating system can be downloaded via digital broadcasting in the U.S.

**Reactivating the temporarily released V-CHIP BLOCK**

You can reactivate the temporarily released V-CHIP BLOCK as shown below.

- Switch off the TV power.

## Example

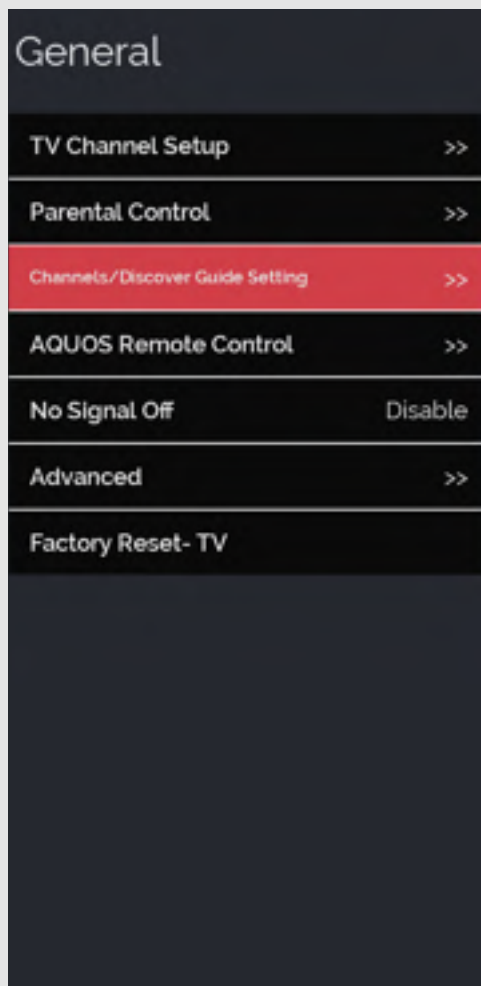

## General (Continue)

## Channels/Discover Guide Setting

## Service Provider Setup

Allows you to configure provider settings.

## Favorite Channel Setting

This function allows you to program favorite channels or applications, in different categories.

By configuring your favorite channels or applications, you can easily check the programs being broadcasted on your favorite channels and easily open applications.

**To register your favorite channel or application:**

Select the desired channel or application from the TV or App list and press ● (ENTER).

- A checkmark will be displayed on the channels and applications registered as favorites.

**To delete your favorite channel or application:**

Select the registered favorite channel or application you want to delete from the TV or App list and press ● (ENTER).

**Saving favorite applications:**

You can also assign favorite applications to the FAVORITE 1, 2 and 3 buttons on the remote control unit.

Favorite applications assigned to ①, ②, and ③ on the Favorite Channel Setting screen are assigned to the FAVORITE 1, 2 and 3 buttons on the remote control unit.

## NOTE

- Only assign applications to the FAVORITE 1, 2 and 3 buttons on the remote control unit.
- When TV tuner channels (AIR/CATV) are assigned to the FAVORITE 1, 2 and 3 buttons on the remote control unit or to other favorite channels, you will not be able to call these channels.

## Search History Reset

Resets the search history.

- This clears the default search history. User account search history will not be affected.

## Recent Tab Reset

Resets the history for the selected channel.

## Example

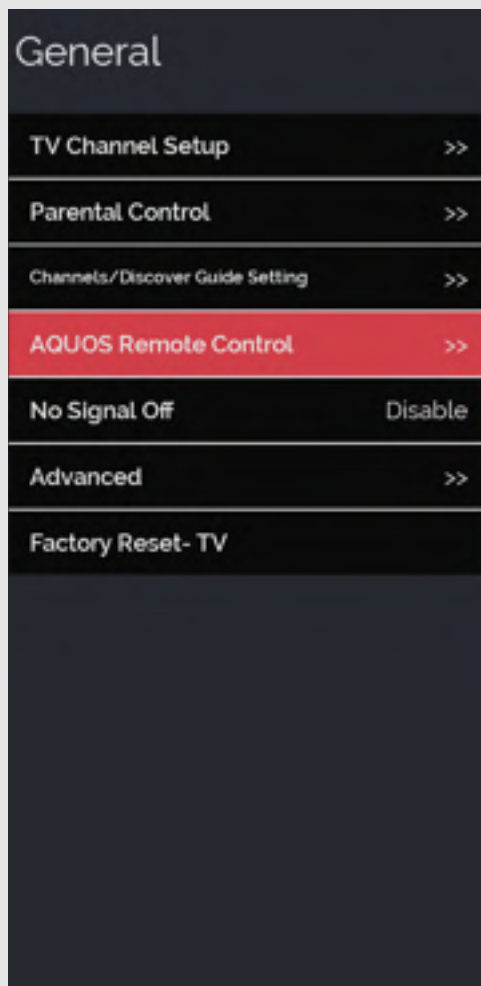

## General (Continue)

## AQUOS Remote Control

Set this function when operating the TV from equipment connected by LAN or wireless LAN.

[\(See page 8-2.\)](#)

## Example

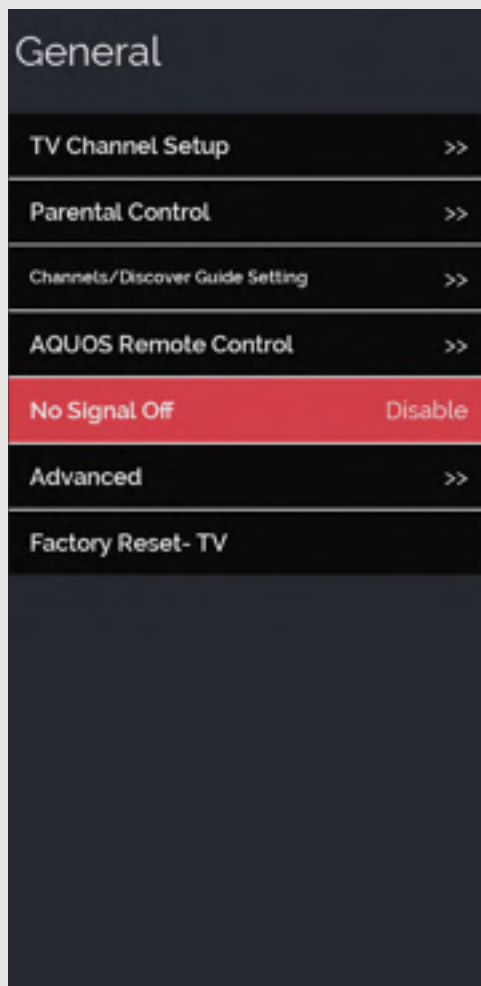

## General (Continue)

## No Signal Off

When this function is enabled, the TV automatically shuts down if no signal is received for more than 15 minutes.

## NOTE

- When it is 5 minutes before the power shuts down, the remaining time will start to keep appearing every minute.
- When a TV program finishes, this function may not operate.

### Example

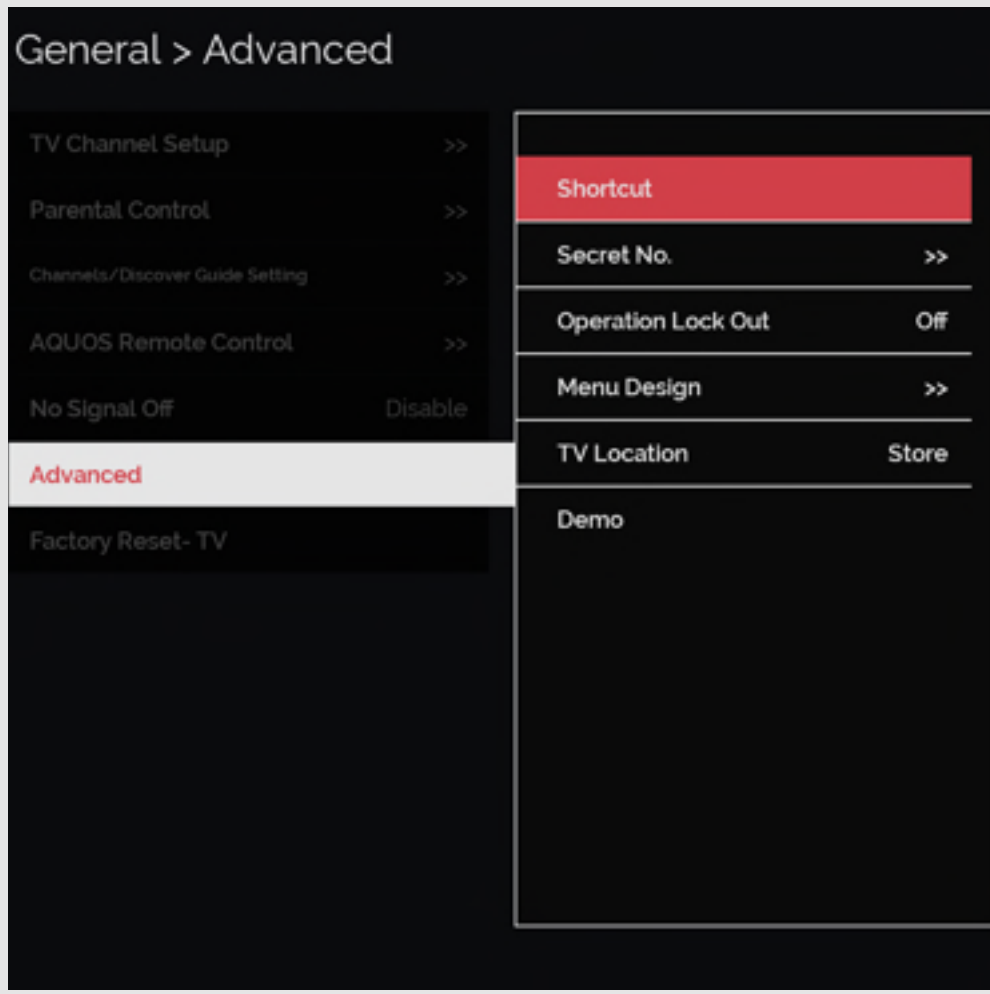

- General (Continue)
- Advanced
- Shortcut

#### Stop Recording

You can stop the recording on the LINK-compatible equipment connected to the TV.

## Example

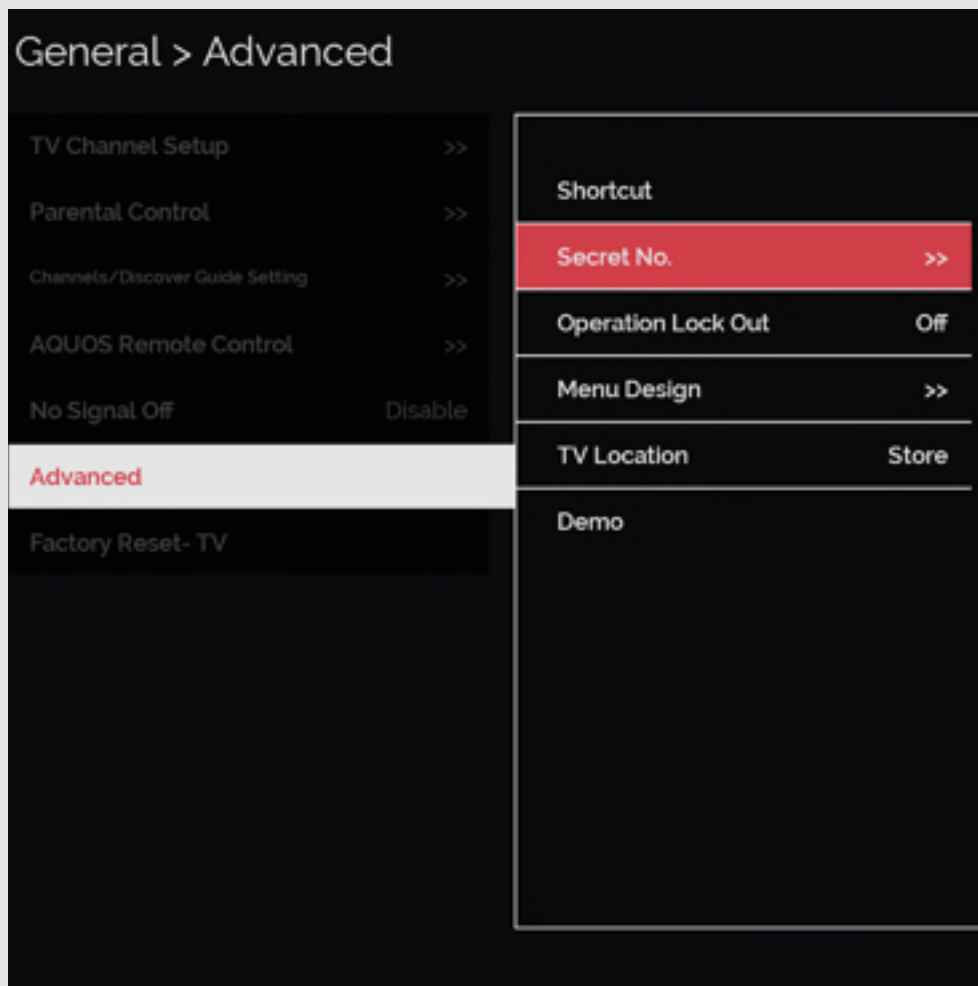

## General (Continue)

## Advanced

## Secret No.

Allows you to use a secret number to protect certain settings from being accidentally changed.

**Input Secret No.:**

Input the Secret No. currently set. (Default: 1234)

**Setting Secret No.**

You can set and change the secret number by using 0-9.

**Yes:** Change or sets the Secret No.

**No:** The previous screen will be displayed.

**NOTE**

- As a precautionary measure, make a note of your secret number and keep it in a familiar place.
- The TV Channel Setup and Parental Control will not be selectable from the menu if you do not first configure your secret number.

## Example

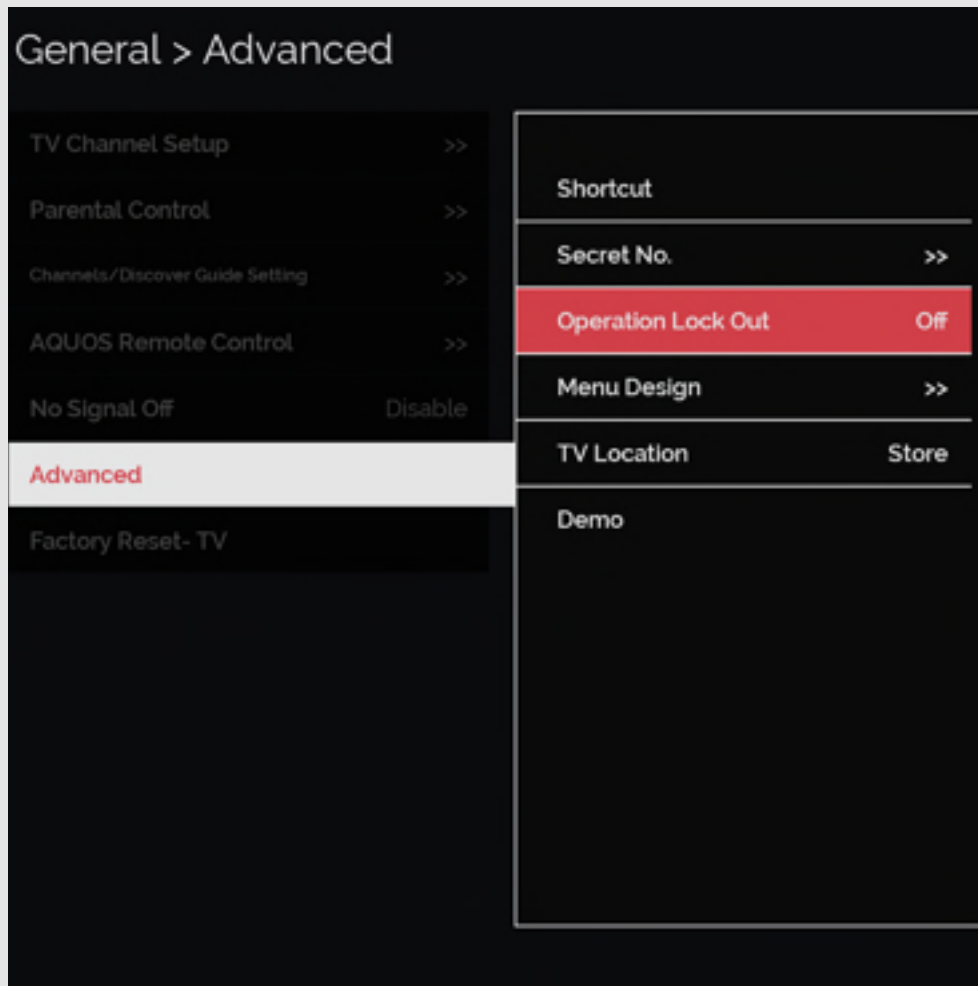

## General (Continue)

## Advanced

## Operation Lock Out

This function locks the operation buttons on the TV and the remote control.

**Off:** No adjustment.

**RC Control Lock:** All buttons on the remote control are locked.

**Button Control Lock:** All buttons on the TV, except **POWER**, are locked.

When "RC Control Lock" or "Button Control Lock" is selected, a confirmation screen appears.

**Yes:** Locks the operation buttons.

**No:** No adjustment.

## NOTE

- To unlock the buttons on the remote control by using the control panel of the TV.  
(See the Setup Guide.)

### Example

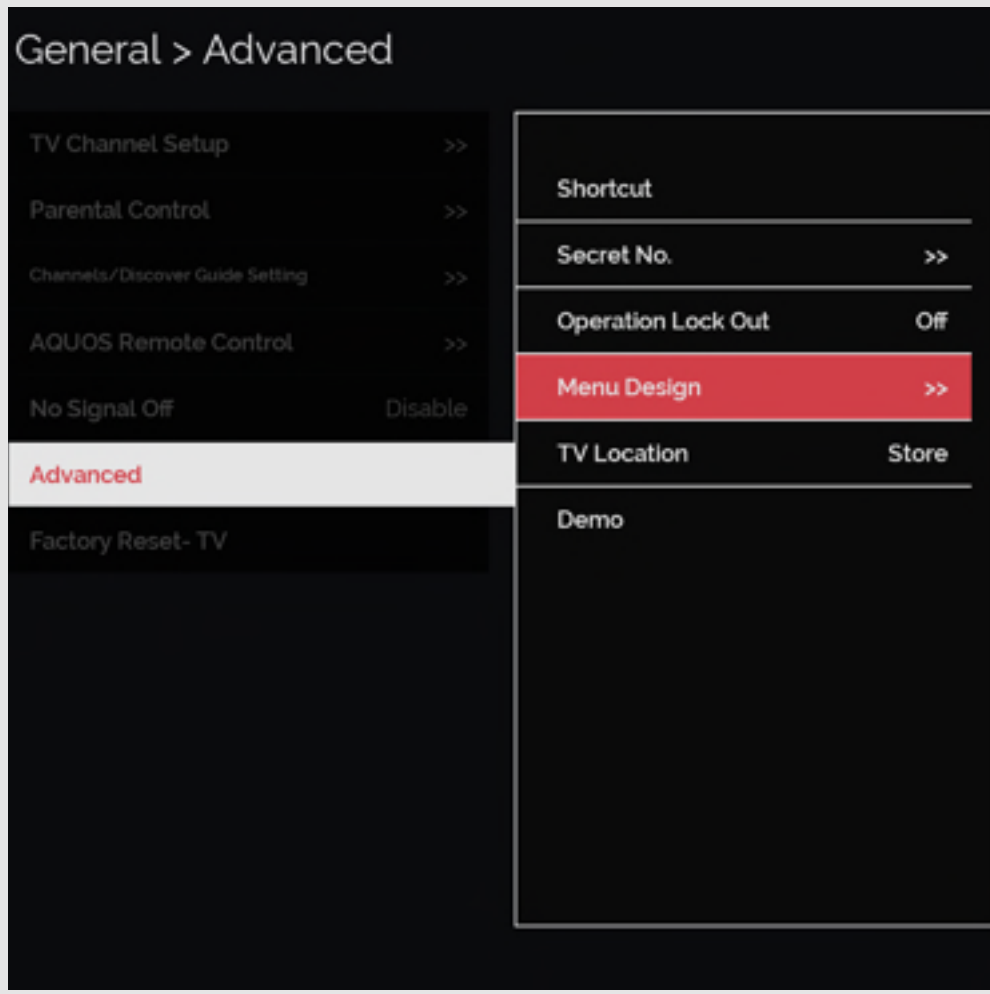

- General (Continue)
- Advanced
- Menu Design

#### Color Scheme

This function allows you to change the color to your liking.



## Example

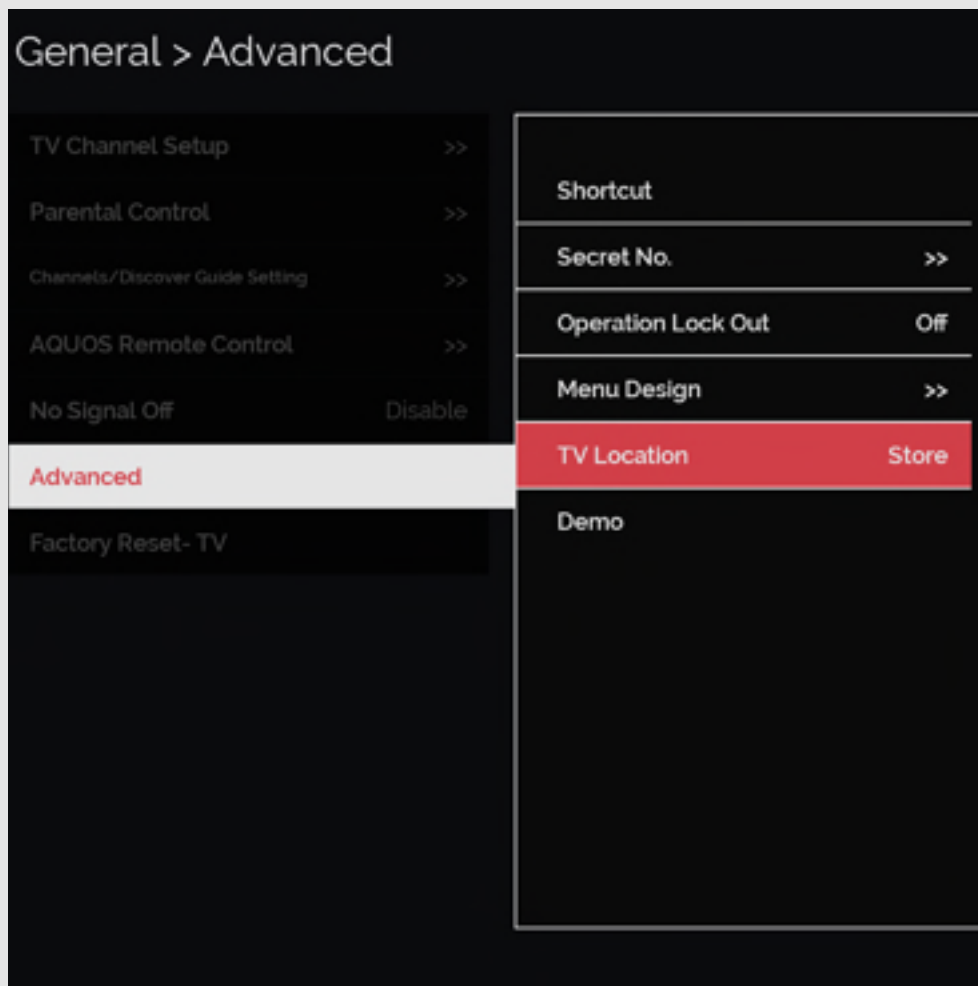

## General (Continue)

## Advanced

## TV Location

Select "Home" or "Store" for the location where you plan to install the TV.

## NOTE

- Normally set "TV Location" to "HOME".
- If you set "TV Location" to "Store", you will not be able to use some menus.
- When using the "Demo" menu, set "TV Location" to "Store".

## Example

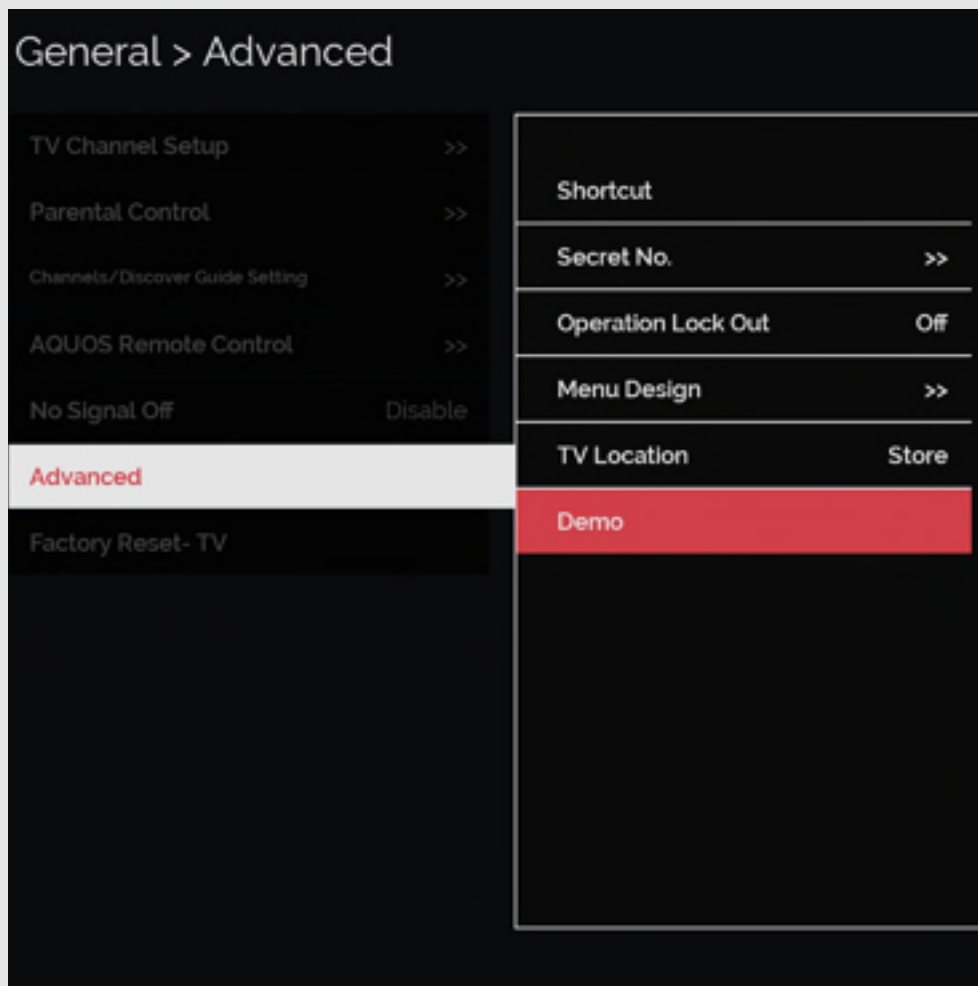

## General (Continue)

Advanced

Demo

You can select the image from several types of demo mode.

## NOTE

- What kinds of setting item are available depends on the model of your TV.
- This function will be canceled when you press EXIT on the remote control unit.
- "Demo" may not be selected depending on input signal type or application status.
- "Demo" may be automatically canceled depending on input signal type.
- When using the "Demo" menu, set "TV Location" to "Store".

## Example

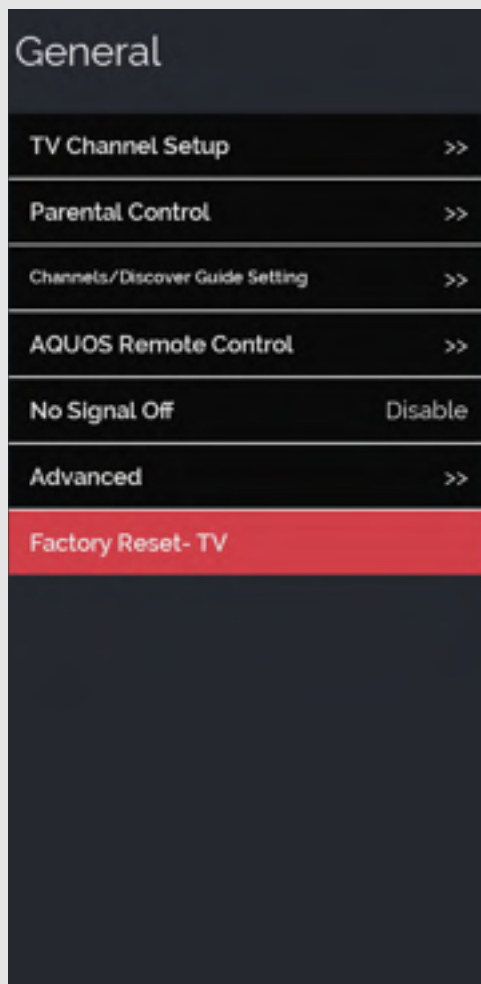

## General (Continue)

## Factory Reset - TV

If complex adjustments are made and the settings cannot be restored to normal, you can reset the settings to the factory preset values.

- If you have already set the Secret No., input the 4-digit secret number here.

## NOTE

- The Language settings will not be changed.
- To reset all data, including Google Accounts, execute "Storage & Reset" from Settings on the HOME screen.

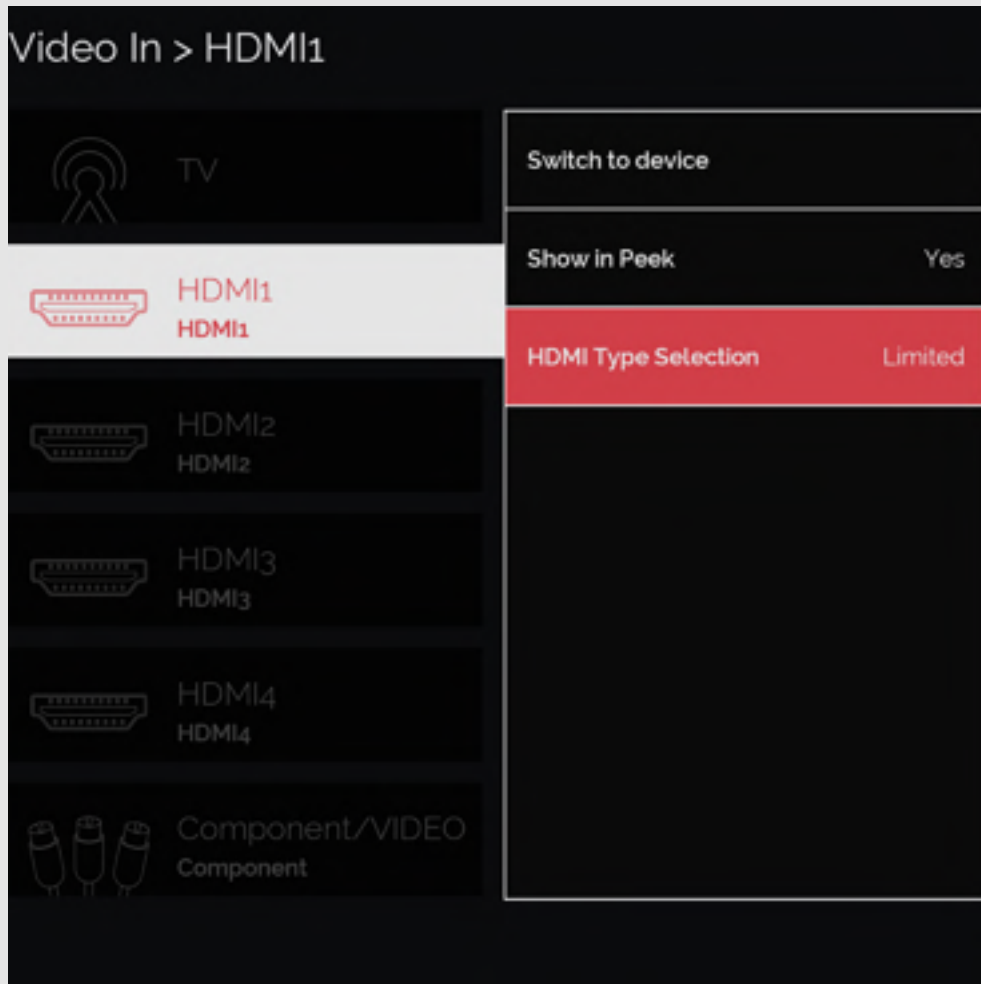

## Video In

### HDMI Type Selection

Sets the HDMI type for HDMI IN 1, 2, 3 and 4 terminals.

Set to "Full" when an HDMI 4K60P 4:4:4 device is connected, and set to "Limited" when an HDMI 4:2:0 device is connected.

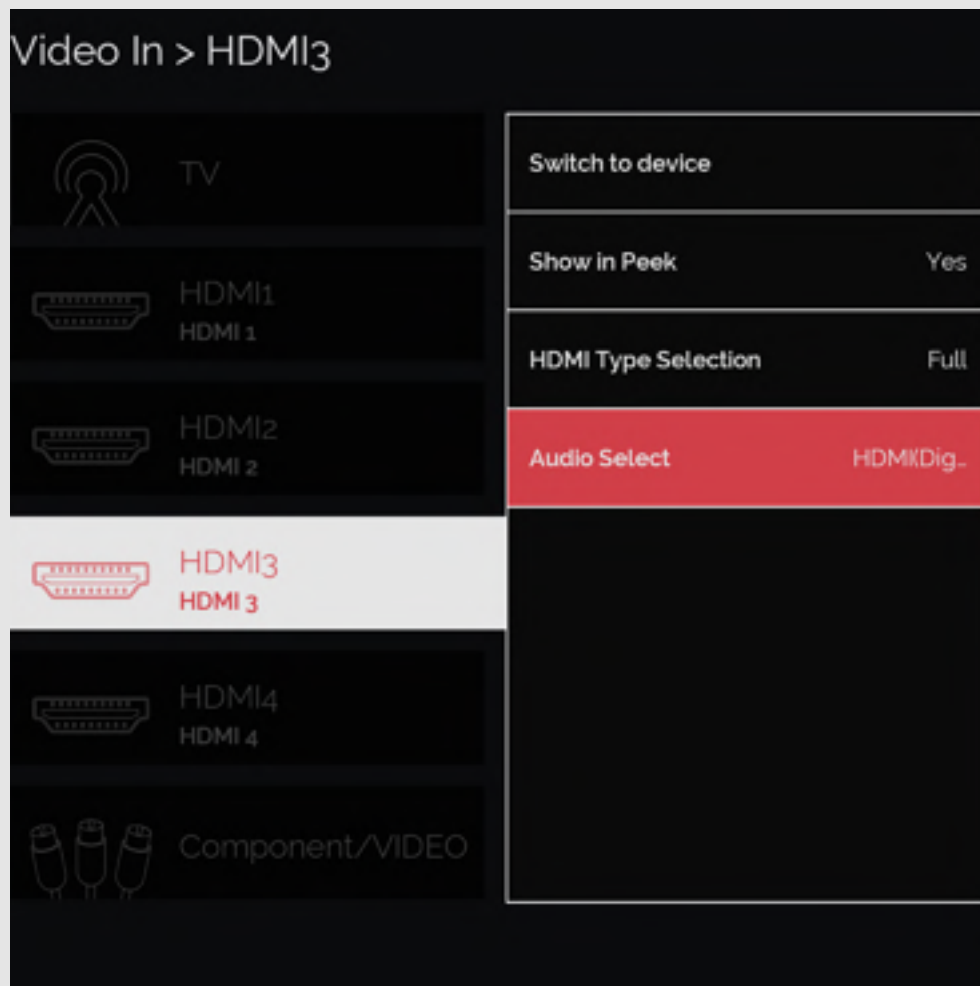

## Video In (Continue)

### Audio Select

This function sets the terminal to output the computer audio.

The adjustment items vary depending on the input source. Select the input source corresponding to the terminal connected to the PC and then adjust the desired item.

To perform the operation, refer to "Devices" > "Video in" > "HDMI 3" > "Audio Select".

### HDMI 3

**HDMI(Digital):** Select this when the TV and PC are connected using an HDMI-certified cable and audio is input via the same cable.

**HDMI+Analog:** Select this when the TV and PC are connected using a HDMI-certified cable and the audio is input via a Ø 3.5 mm stereo minijack.

### NOTE

- When "Audio Select" is set to "HDMI+Analog", sound will not be produced if you use only an HDMI-certified cable to connect HDMI-compatible equipment. To produce sound, you should make an analog audio connection.
- If you want to connect HDMI-compatible equipment using only an HDMI-certified cable, set "Audio Select" to "HDMI(Digital)".
- "Audio Select" can only be set for the HDMI IN 3.

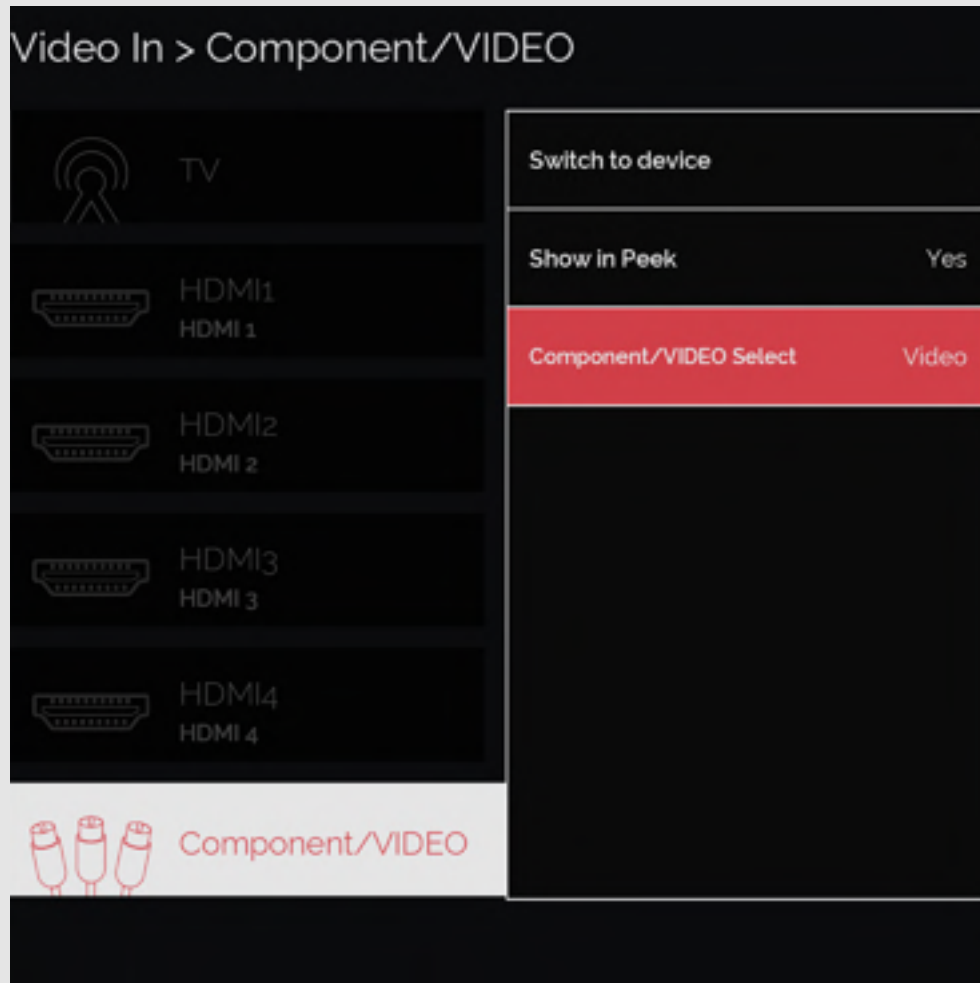

### Video In (Continue)

#### Component/VIDEO Select

For image input applied to the COMPONENT IN or VIDEO IN terminal, switch to "Component" or "Video", respectively.

**Component:** Select component video.

**Video:** Select composite video.

#### NOTE

- If no (color) image displays, try changing to another signal type.
- Check the operation manual of the external equipment for the signal type.

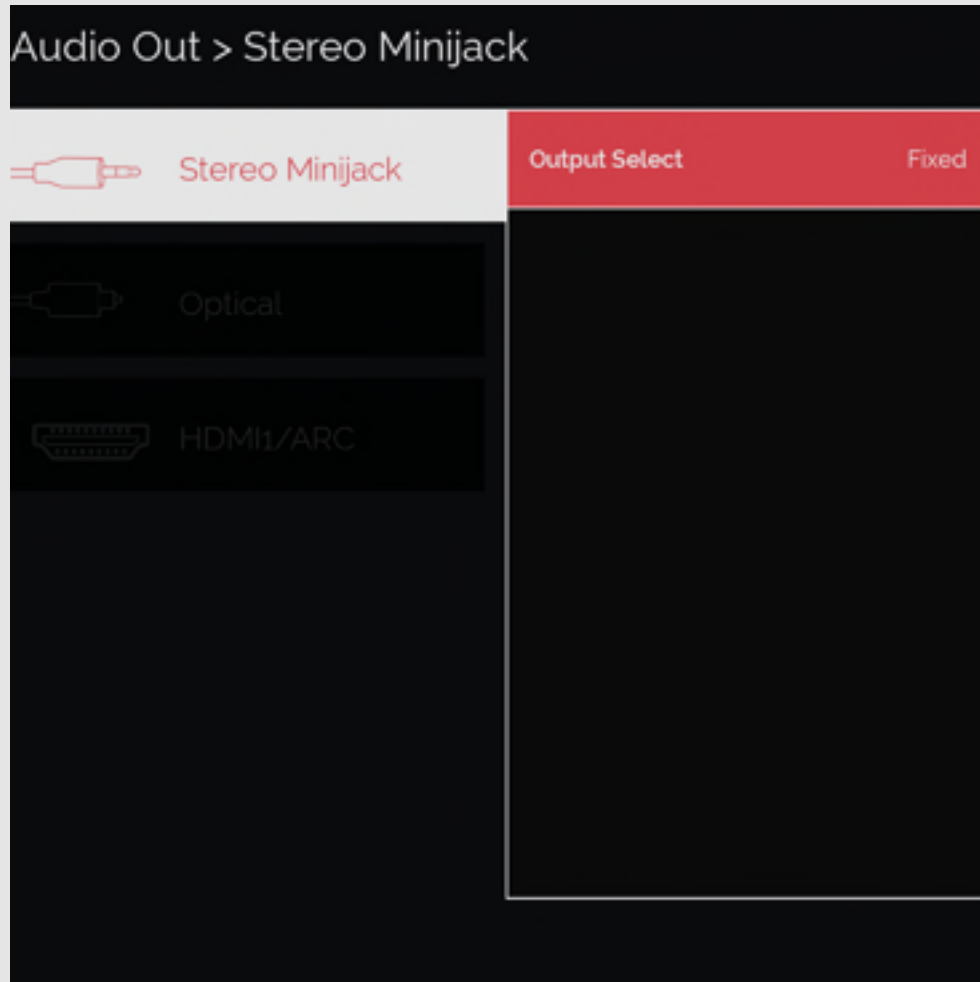

## Audio Out

### Output Select

Allows you to select what controls the audio output.

**Fixed:** Sound via speaker is adjusted with **VOL+/-** on the remote control unit or on the TV.

Sound via the AUDIO OUT terminal is not adjustable and outputs at a consistent level.

**Variable:** Sound via the AUDIO OUT terminal is adjusted with **VOL+/-** on the remote control unit or on the TV.  
Sound via speaker is muted.

### NOTE

- "Output Select" does not operate for Bluetooth devices.

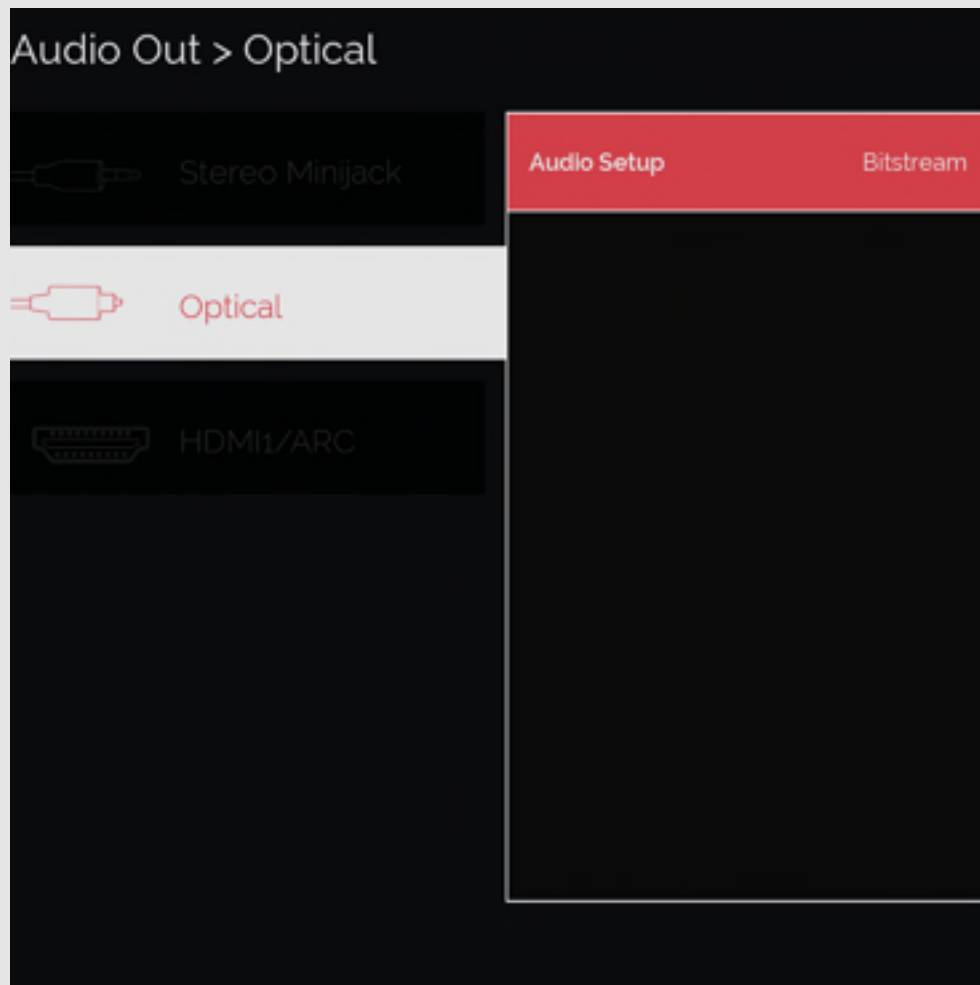

## Audio Out (Continue)

### Audio Setup

You can output digital audio to an AV amplifier or similar device whose DIGITAL AUDIO INPUT terminal is connected to the DIGITAL AUDIO OUT terminal on the TV. Please select an audio output format compatible with the audio format of the program you are watching and the equipment connected.

**PCM:** For connecting to equipment that does not support Dolby Digital. The same audio (main, sub, or main/sub) as the audio of the program being viewed is output.

2-channel audio with a sampling rate of 48 kHz or less is output as linear PCM audio.

**Bitstream:** For connecting to an audio system that supports Dolby Digital. Audio is output through both the main and sub channels.

### NOTE

- Analog channel audio, Video/Component input audio, PC input audio and HDMI-Analog input audio are output in PCM mode even when "Bitstream" is selected.
- PCM digital input signals are output in PCM mode even when "Bitstream" is selected.
- "Audio Setup" does not operate for Bluetooth devices.



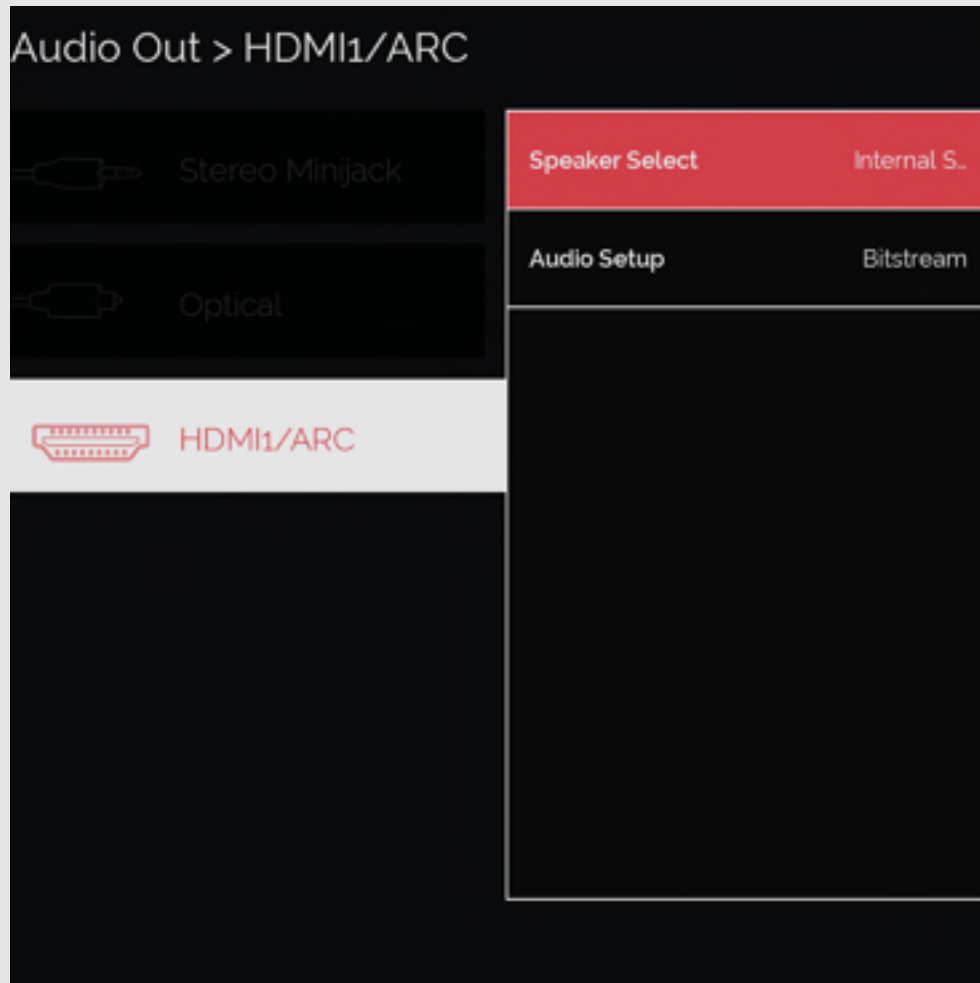

### Audio Out (Continue)

#### Speaker Select

You can select to listen to the TV sound only from the LINK-compatible audio system.

**Internal Speaker:** The sound is output from the TV speaker.

**External Devices:** The sound from the TV speaker is muted and only the sound from the LINK-compatible audio system is audible.

- You can use VOL+/- and MUTE.

#### NOTE

- "Speaker Select" does not operate for Bluetooth devices.

#### Audio Setup

You can output digital audio to an AV amplifier or similar device whose HDMI terminal is connected to the HDMI1/ARC terminal on the TV. Please select an audio output format compatible with the audio format of the program you are watching and the equipment connected.

[\(See page 4-5.\)](#)



## Changing Channels

You can change channels in several ways.

### Method 1

Using CH  $\wedge$  /  $\vee$  on the remote control unit or on the TV.

### Method 2

Using remote control buttons 0-9, • (DOT).

#### Examples:

To select a 1 or 2-digit channel number (e. g., Channel 5):

Press 5 → ENT

To select a 3-digit channel number (e. g., Channel 115):

Press 1 → 1 → 5 → ENT

To select a 4-digit channel number (e. g., Channel 22.1):

Press 2 → 2 → • (DOT) → 1 → ENT

## NOTE

- When selecting a 1-digit channel number, it is not necessary to press 0 before the number.
- When you enter 0-9 only, channel selection will be made if there is no operation within a few seconds.
- If you push "0" by itself, nothing will happen.
- Complete the above steps within a few seconds.
- When you enter 0-9 and • (DOT), channel selection will be made if there is no operation within a few seconds.



## Changing Volume

You can change the volume by pressing VOL+/- on the TV or on the remote control unit.

- To increase the volume, press VOL +.
- To decrease the volume, press VOL -.



### Audio status

Contents	Output device	Output Select	
		Fixed	Variable
TV, HDMI, Component, Composite, Content Player, Vudu	TV Speaker	Variable Sound	Mute
	AUDIO OUT	Fixed Sound (Volume MAX)	Variable Sound
	DIGITAL AUDIO OUT, HDMI IN 1 (ARC)	Fixed Sound (Volume MAX)	Fixed Sound (Volume MAX)
YouTube, Netflix, Google Play [Movies&TV] and Android APP	TV Speaker	Variable Sound	Mute
	AUDIO OUT	Same volume as a TV speaker	Variable sound
	DIGITAL AUDIO OUT, HDMI IN 1 (ARC)	Same volume as a TV speaker	Same volume as an AUDIO OUT



## MUTE

Mutes the current sound output.

Press **MUTE**.

-  will be displayed on the screen for 30 minutes.

### NOTE

- Mute can be canceled by pressing **VOL+/-** or **MUTE**.



## FLASHBACK

Press **FLASHBACK** to switch to the previously tuned channel or previous input mode.

- Press **FLASHBACK** again to switch back to the currently tuned channel.

## NOTE

- **FLASHBACK** will not work if no channel has been changed after the TV is turned on.
- With **FLASHBACK**, only input from TV, HDMI 1 through 4, or Video/Component will be stored in Memory.





## AUDIO

### MTS/SAP stereo mode

The TV has a feature that allows reception of sound other than the main audio for the program. This feature is called Multi-channel Television Sound (MTS). The TV with MTS can receive mono sound, stereo sound

and Secondary Audio Programs (SAP). The SAP feature allows a TV station to broadcast other information, which could be audio in another language or something completely different like weather information.

You can enjoy Hi-Fi stereo sound or SAP broadcasts where available.

- **Stereo broadcasts:** View programs like live sporting events, shows and concerts in dynamic stereo sound.
- **SAP broadcasts:** Receive TV broadcasts in either MAIN or SAP sound.  
 MAIN sound: The normal program soundtrack (either in mono or stereo).  
 SAP sound: Listen to a second language, supplementary commentary or other information. (SAP is mono sound.)

If stereo sound is difficult to hear.

- Obtain a clearer sound by manually switching to fixed mono-sound mode.

You can change MTS as shown below to match the television broadcast signal.

Press to toggle between audio modes.

### Examples: when receiving MTS and SAP

STEREO mode: STEREO ↔ MONO  
 STEREO + SAP mode: STEREO → SAP → MONO  
 MONO + SAP mode: MONO ↔ SAP  
 MONO mode: MONO

### Digital broadcasting audio mode

The types of audio transmitted in a digital broadcast include SURROUND as well as MONO and STEREO. In addition, it is possible for multiple audio tracks to accompany a single video track.

Press **AUDIO** to toggle between audio modes.

Example: when receiving Digital broadcasting

STEREO (Audio1) → STEREO (Audio2)  
 ← SURROUND (Audio3) ←

### NOTE

- MTS only operates while in TV mode.



## Sleep Timer

Allows you to set a time when the TV automatically switches to standby.

Press **SLEEP**.

- The remaining time displays when the sleep timer has been set.
- Each time you press **SLEEP**, the remaining time switches as shown below.

OFF → 30min → 60min → 90min  
 ↻ 180min ← 150min ← 120min ↻

- When set, the time automatically starts counting down.
- If you want to adjust the sleep timer, you can press **SLEEP** twice then change the time setting.
- When it is 5 minutes before the time expires, the remaining time will start to keep appearing every minute.

### NOTE

- Select "Off" by pressing **SLEEP** to cancel the sleep timer.
- The TV will enter standby when the remaining time reaches 0.





## Closed Captions and Digital Closed Captions

Your TV is equipped with an internal Closed Caption decoder. It allows you to view conversations, narration and sound effects as subtitles on your TV. Closed Captions are available on some TV programs and on some VHS home video tapes at the discretion of the program provider.

Digital Closed Caption service is a new caption service available only on digital TV programs (also at the discretion of the service provider). It is a more flexible system than the original Closed Caption system, because it allows for a variety of caption sizes and font styles. When the Digital Closed Caption service is in use, it will be indicated by the appearance of a 3-letter abbreviation that also indicates the language of the Digital Closed Captions: ENG (English), SPA (Spanish), FRA (French) or other language codes.

Not all programs and VHS videotapes offer closed captions. Please look for the "CC" symbol to ensure that captions will be shown.

In the Closed Caption system, there can be more than one caption service provided. Each is identified by its own number. The "CC1" and "CC2" services display subtitles of TV programs superimposed over the program's picture. In the Closed Caption system, the "Text1" or "Text2" services display text that is unrelated to the program being viewed (e.g., weather or news). These services are also superimposed over the program currently being viewed.

### 1 Press CC.

- This will present the Closed Caption information display.

### 2 Press CC while the Closed Caption information is still on the screen.

- Press repeatedly until you select the desired closed caption service.

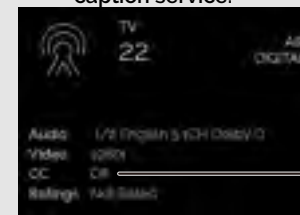

Closed Caption information

- The CC button keeps a record of the last service selected in its memory. If the last closed caption mode (e.g. ENG) you selected is not available for the next program, or on another channel, the closed caption service that is available is automatically selected, and this service appears in parentheses, e.g. "ENG". Closed Caption services that appear in parentheses will not be stored in the CC button's memory as your last selected service. Only services that you have selected with the CC button are stored.

ENG 5-8

ENGLISH | FRANÇAIS | ESPAÑOL



## Closed Captions and Digital Closed Captions (Continue)

### Examples:

In a case where there are two closed caption services provided (for instance, Digital CC(ENG) and CC1), and Digital CC(ENG) is displayed as your current selection, if Digital CC(ENG) is not broadcast for the next program, the other closed caption service, CC1, will be displayed in parentheses.

A closed caption service appears in parentheses because the service you selected is not available and a different service is displayed on your screen. "1/1(CC1)" is displayed instead of "1/2/ENG".

### NOTE

- When the program contains no closed caption, "--" displays in the closed caption information.
- If the language code, e.g. "ENG", is not found on Digital TV programs, "--" will be shown.
- Four kinds of closed caption service (CC1, CC2, Text1, Text2) are potentially available, but a broadcast may contain none or only some of these services at the discretion of the program provider.
- When a web page is displayed, Closed Captions are not available.



## VIEW MODE

You can select the screen size.

### 1 Press VIEW MODE.

- Current View Mode is displayed.

### 2 Press VIEW MODE while the View Mode indicator is displayed to select a desired item on the menu.

- View Mode will toggle within selectable options for the type of video signal currently being received when you press VIEW MODE button.

### For HD programs

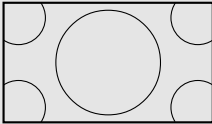
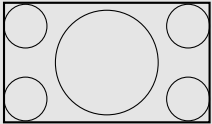
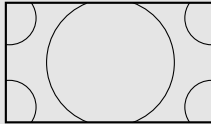
Stretch	Dot by Dot (Full Screen)	Zoom
 <p>Suitable for viewing wide-screen 1.78:1 aspect ratio program, stretch mode will still show very thin black bands at the top and bottom of the screen.</p>	 <p>"Dot by Dot" when the number of pixels on the screen and the resolution of the signal are the same. "Full Screen" when the number of pixels on the screen and the resolution of the signal are different. In either case, the image fully fills the screen.</p>	 <p>Suitable for viewing wide-screen 2.35:1 aspect-ratio programs in full screen.</p>

## NOTE

- When using Dot by Dot or Full Screen, it is possible to see noise or bars around different outer portions of the screen. Please change view mode to correct this.
- This feature is available with TV, HDMI IN 1-4, and Video/Component input. Availability in other input modes varies according to the individual App specifications.



## VIEW MODE (Continue)

For 4:3 programs  
 Example: Screen size images

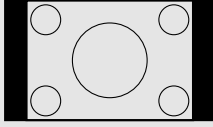
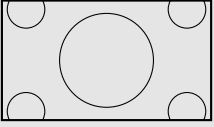
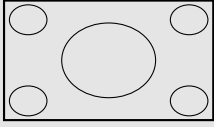
Side Bar	Zoom	Stretch
 <p data-bbox="817 486 1198 542">Suitable for viewing conventional 4:3 programs in their normal format.</p>	 <p data-bbox="1232 486 1624 542">Suitable for viewing wide-screen 2.35:1 anamorphic DVDs in full screen.</p>	 <p data-bbox="1646 486 2060 590">This mode is useful for 1.78:1 DVDs. When viewing 1.85:1 DVDs, stretch mode will still show very thin black bands at the top and bottom of the screen.</p>



## VIEW MODE (Continue)

For PC  
 Example: Screen size images

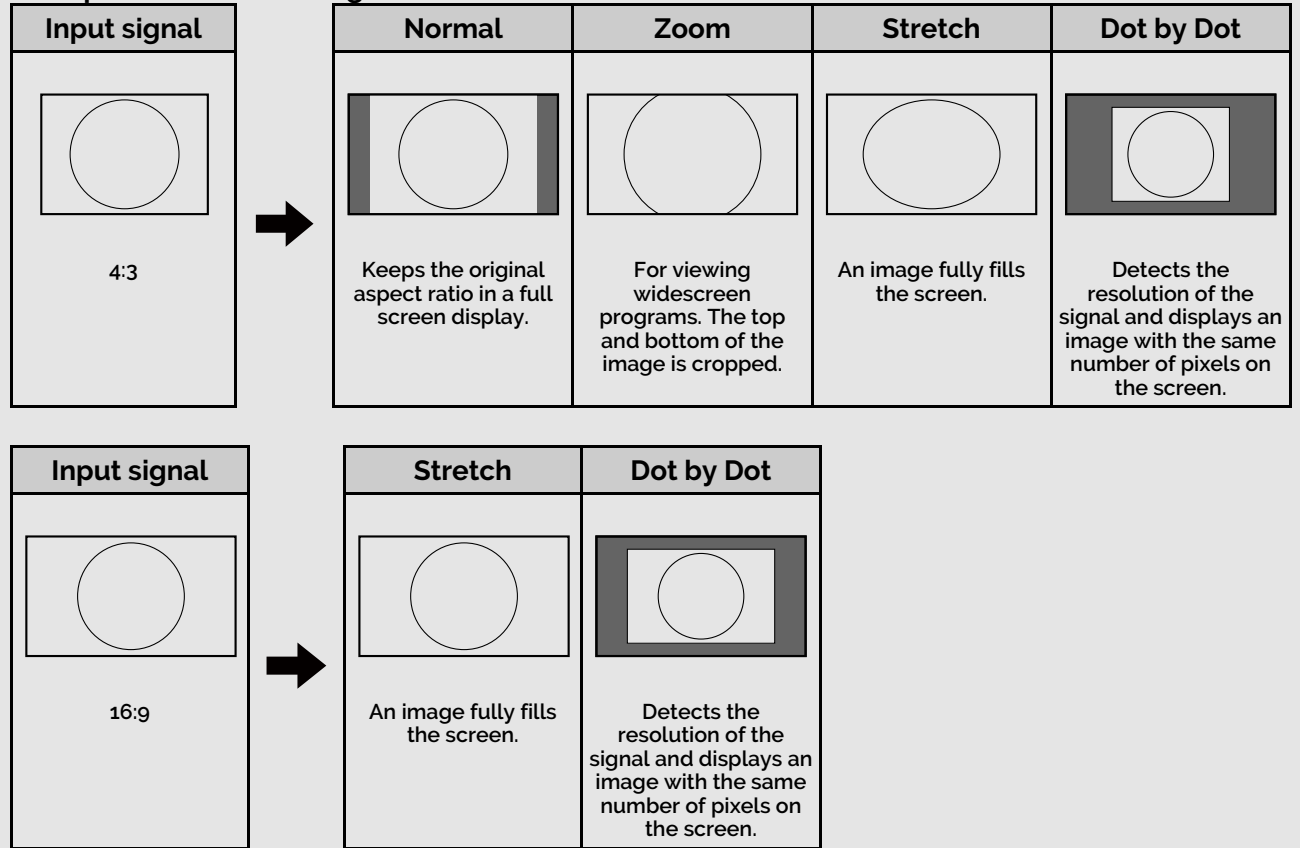

### NOTE

- Connect the PC before making adjustments. See the Setup Guide.
- Selectable screen size may vary with input signal type.



## Remote Control Panel

Press **MORE** to display the Remote Control Panel.

The "AV Mode", "View Mode", "Equalizer", "Sleep" and "Audio Only" menus can be configured.



See [pages 3-2, 3-26, 5-7](#) and [5-10](#) for details on the settings for "AV Mode", "View Mode", "Equalizer" and "Sleep" menus.

## Audio Only

When listening to music from a music program, you can turn the screen off and enjoy audio only.

### NOTE

- The screen image will return to normal when a button (except those for audio adjustment, such as **VOL**, **MUTE**) is pressed.

## Preparation

You can connect the TV to a USB memory device, USB hard drive, SD memory card\*1, Home Network server, Smartphone or Tablet to enjoy viewing pictures, listening to music, and watching videos.

### NOTE

- Depending on the USB memory device/USB hard drive/SD memory card\*1/Home Network server, the TV may not be able to recognize the recorded data.
- It may take time to read the recorded data if the USB memory device/USB hard drive/SD memory card\*1/Home Network server contains many files or folders.
- Use only alphanumeric characters for naming files.
- File names over 80 characters (may vary depending on character set) may not be displayed.

### Connecting a USB Memory Device/USB Hard Drive/SD Memory Card\*1

Insert the USB memory device or SD memory card\*1 with recorded photos, music or videos into the USB 1, USB 2 or USB 3 terminal or SD memory card slot\*1 on the TV.

- If USB memory devices are inserted into multiple terminals, the USB 1 terminal has priority.

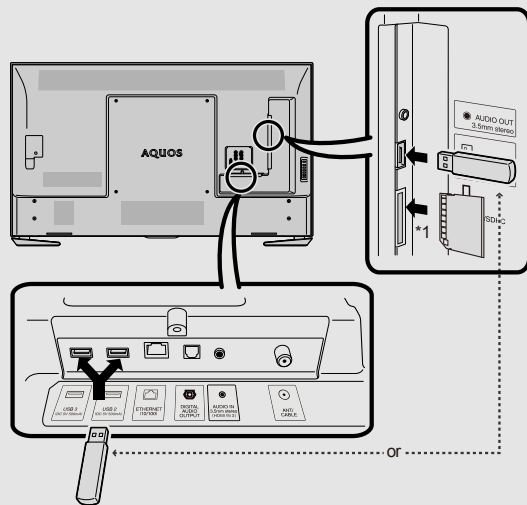

- When connecting a USB hard drive, be sure to use a hard drive with an AC adapter.
- Do not remove a USB memory device or SD memory card\*1 from the TV while transferring files, using the slide show function, or switching screens, or before you exit "Content Player".
- Do not insert and remove a USB memory device/USB hard drive/SD memory card\*1 to and from the TV repeatedly.
- When using a card reader, be sure to insert a USB memory device first.

### CAUTION

- Do not use a USB extension cable when connecting a USB memory device to the USB terminal on the TV.
- Using a USB extension cable with the USB memory device may prevent the TV from performing correctly.

### Connecting a Home Network Server

- Connect the TV to the Home Network server using an ETHERNET cable.
- You can also connect a Home Network server by using a wireless LAN.

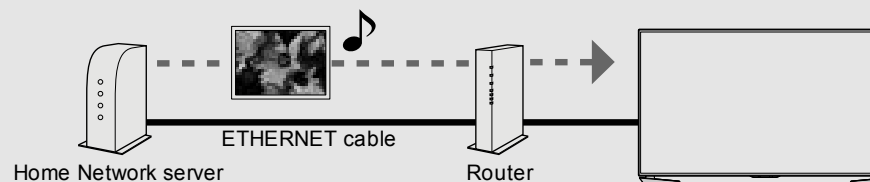

### NOTE

- Do not disconnect a Home Network server from the TV while transferring files, when a screen is switching to another or before you exit "Content Player".
- Do not connect and disconnect a Home Network server from the TV repeatedly.

\*1 For UH30U model only.



## Selecting the Folders to Play Back

- To play back data on a USB memory device or SD memory card\*1, insert the USB memory device on the TV.
- 1 Select "Content Player" from the Devices screen, or launch the Content Player app from HOME screen.
- 2 Press ◀ / ▶ to select "Photo", "Music" or "Video", and then press ● (ENTER).

### Example

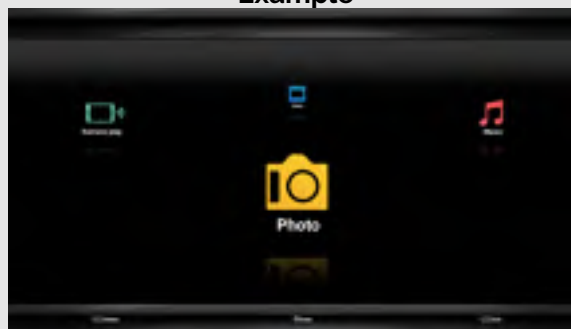

- 3 Press ▲ / ▼ (or ◀ / ▶) to select the drive/server where you want to find your file, and then press ● (ENTER).
- 4 Press ◀ / ▶ to select the desired folder, and then press ● (ENTER).

\*1 For UH30U model only.

## NOTE

- If the TV is turned off and then on again, the number assigned to the USB may change.

### USB Device Compatibility

USB device	USB Memory, USB card reader (Mass Storage class), USB hard drive
File system	FAT/FAT32

### SD memory card Compatibility

SD card	SD/SDHC memory card
File system	FAT/FAT32

### Photo file format

Format	JPEG, PNG, BMP
--------	----------------

### Music file format

Format	Sampling rate [KHz]	Bitrate [Kbps]
MP3	8/11.025/12/16/22.050/24/32/44.1/48	8~320
AAC	32/44.1/48	8~320
WMA	8/11.025/16/22.05/32/44.1/48/64/88.2/96	8~384
WAV	8/11.025/12/16/22.050/24/32/44.1/48	8~1024





## Selecting the Folders to Play Back (Continue)

### Video file format

Container	Video	Audio
AVI	MPEG-1 MPEG-2 MPEG-4 H.264	PCM MP2: MPEG-1 Layer2 MP3: MPEG-1 Layer3 AAC AC3 WMA
MKV	MPEG-1 MPEG-2 MPEG-4 H.264 VP8 H.265(HEVC)	PCM MP2: MPEG-1 Layer2 MP3: MPEG-1 Layer3 AAC AC3 WMA VORBIS DTS
ASF	MPEG-4 VC1(WMV3)	MP3: MPEG-1 Layer3 WMA
PS	MPEG-1 MPEG-2	MP2: MPEG-1 Layer2 MP3: MPEG-1 Layer3 AC3 DTS
TS	MPEG-2 VC1(WMV3) H.264 H.265(HEVC)	MP2: MPEG-1 Layer2 AAC AC3 DTS
MP4	MPEG-4 H.264 H.265(HEVC) VP8 VC1(WMV3)	MP2: MPEG-1 Layer2 MP3: MPEG-1 Layer3 AAC

### NOTE

- Progressive format jpeg files are not supported.
- USB 1.1 devices may not be played properly.
- Operation using USB hubs is not guaranteed.
- Some video file formats may not be played depending on the file.
- Some images may not be displayed in the appropriate aspect ratio depending on the file format.
- File extensions are not used to determine the file format.
- If you insert any card other than the SD/SDHC (class 6 or higher), it will not work.(For UH30U model)

### Home Network Server Compatibility

Photo file format	JPEG
Music file format	WAV, MP3
Video file format	MPEG2-PS, MPEG2-TS, WMV, ASF, MP4, MOV, AVI

### NOTE

- Progressive format jpeg files are not supported.
- Some video file formats may not be played depending on the file or the server.



## Playing Back Files on a USB Memory Device/SD Memory Card/Home Network Server

Photo Mode

Viewing Thumbnails

Example



### Buttons for thumbnail/list operations

Buttons	Description
▲ / ▼	Select a desired item.
◀	In Thumbnail mode: Select a desired item. In List mode: Return to the previous process.
▶	In Thumbnail mode: Select a desired item. In List mode, when selecting a folder icon: Enter this directory. In List mode, when selecting a photo file: Enlarge the photo.
● (ENTER)	When selecting a folder icon: Enter this directory. When selecting a photo file: Enlarge the photo.
(Back)	In Thumbnail mode: Return to the previous process. In List mode: Exit application.
C (blue)	Change Thumbnail/List mode.
D (yellow)	Display the Menu screen.

Menu for thumbnail operations  
Press ▲ / ▼ to select an item and make settings to your preferences.

Example

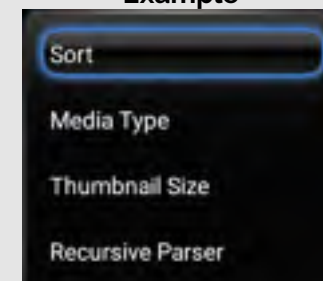

### Sort

You can change the way in which files are ordered.

Press ▲ / ▼ to select "Type", "Date" or "Name", and then press ● (ENTER).

### Media Type

Switch the media type when the Recursive Parser display is displayed.

### Thumbnail Size

Change the thumbnail size.

Small/Medium/Large

### Recursive Parser

Display all files according to the Media Type settings.

### NOTE

- You can see the file name, file size and pixel size of the selected photo in the upper-left corner of the screen.
- When you are viewing the Content Player app, you cannot configure Picture/Audio settings.



## Playing Back Files on a USB Memory Device/SD Memory Card/Home Network Server (Continue)

### Slide Show

The photos displayed on the thumbnail selection screen are displayed as a slide show.

### Buttons for slide show operation

Buttons	Description
▶	Play the Slide Show.
⏸	Pause the Slide Show.
▲/▼/◀/▶, ● (ENTER)	Select the desired item.
(Back)	Return to the thumbnail selection screen.
D (yellow)	Display the USB Menu screen.

### Menu for slide show

#### Example

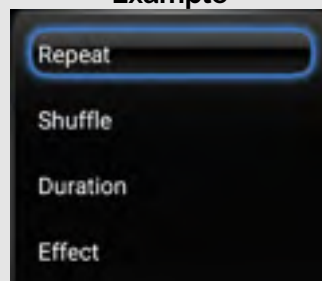

### Repeat

Set whether to show the slide show repeatedly.

None/Repeat One/Repeat All

### Shuffle

Shuffle the image files within the folder and display as a slide show.

### Duration

Specify the length of time before the next image appears.

Press ▲ / ▼ to select the desired length of the time, and then press ● (ENTER).

Short/Medium/Long

### Effect

Specify the effect for transitioning to the next image.

None/Dissolve/Wipe right/Wipe left/Wipe up/Wipe down/Box in/Box out/Random

### Rotate\*

Rotate the photo by 90 degrees to the right.

\* Only displayed when playback is paused.

### Zoom\*

Zoom in on the image.

Normal/Zoom1/Zoom2

\* Only displayed when playback is paused.

### Sort

You can change the way in which files are ordered.

Press ▲ / ▼ to select "Type", "Date" or "Name", and then press ● (ENTER).

### NOTE

- The slide show continues until you press (Back).
- For setting the slide show speed, select "Duration" on the Menu screen.



## Playing Back Files on a USB Memory Device/SD Memory Card/Home Network Server (Continue)

### Music Mode

### Viewing Thumbnails

#### Example

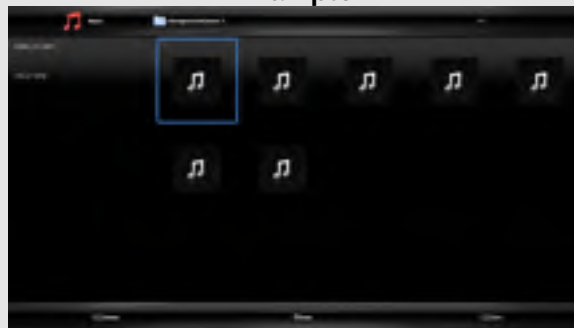

### Buttons for thumbnail/list operations

Buttons	Description
▲ / ▼	Select a desired item.
◀	In Thumbnail mode: Select a desired item. In List mode: Return to the previous process.
▶	In Thumbnail mode: Select a desired item. In List mode, when selecting a folder icon: Enter this directory. In List mode, when selecting a music file: Play music.
● (ENTER)	When selecting a folder icon: Enter this directory. When selecting a music file: Play music.
◀ (Back)	In Thumbnail mode: Return to the previous process. In List mode: Exit application.
C (blue)	Change Thumbnail/List mode.
D (yellow)	Display the Menu screen.

ENG 6-6

### NOTE

- When you are viewing the Content Player app, you cannot configure Picture/Audio settings.

### Menu for thumbnail operations Example

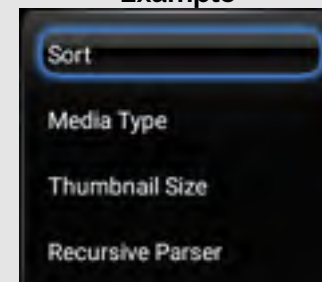

#### Sort

You can change the way in which files are ordered.

Press ▲ / ▼ to select "Date", "Genre", "Artist" or "Album", and then press ● (ENTER).

#### Media Type

Switch the media type when the Recursive Parser display is displayed.

#### Thumbnail Size

Change the thumbnail size.  
Small/Medium/Large

#### Recursive Parser

Display all files according to the Media Type settings.



## Playing Back Files on a USB Memory Device/SD Memory Card/Home Network Server (Continue)

### Playing Mode

#### Buttons for playing mode

Buttons	Description
◀◀	The fast revers speed changes every time you press ◀◀.
▶▶	The fast forward speed changes every time you press ▶▶.
⏸	Pause the music.
◀◀	Go to the previous file.
▶▶	Go to the next file.
▲/▼/◀/▶, (ENTER)	Select a desired item.
(Back)	Return to the previous process.
D (yellow)	Display the Manu screen.

#### NOTE

- The displayed play time may differ slightly from the actual play time depending on the files.

#### Menu for playing mode

##### Example

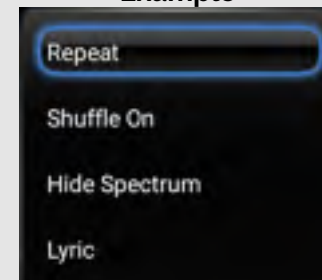

#### Repeat

Configure the repeat playback settings.  
None/Repeat One/Repeat All

#### Shuffle

Shuffle the music within the folder.

#### Hide Spectrum/Show Spectrum

Show or hide the spectrum.

#### Lyric

You can change the lyric display type. This is only available when a lyrics file (".lrc") is present. Only UTF-8 character code lyric files (without BOM) are supported.



## Playing Back Files on a USB Memory Device/SD Memory Card/Home Network Server (Continue)

Video Mode

### Viewing Thumbnails

#### Example



### Buttons for thumbnail/list operations

Buttons	Description
▲ / ▼	Select a desired item.
◀	In Thumbnail mode: Select a desired item. In List mode: Return to the previous process.
▶	In Thumbnail mode: Select a desired item. In List mode, when selecting a folder icon: Enter this directory. In List mode, when selecting a video file: Play the video file.
● (ENTER)	When selecting a folder icon: Enter this directory. When selecting a video file: Play the video file.
(Back)	In Thumbnail mode: Return to the previous process. In List mode: Exit application.
C (blue)	Change Thumbnail/List mode.
D (yellow)	Display the Menu screen.

ENG 6-8

### Menu for thumbnail operations Example

#### Sort

You can change the way in which files are ordered.

Press ▲ / ▼ to select "Type", "Date" or "Name", and then press ● (ENTER).

#### Media Type

Switch the media type when the Recursive Parser display is displayed.

#### Thumbnail Size

Change the thumbnail size.  
Small/Medium/Large

#### Recursive Parser

Display all files according to the Media Type settings.

#### NOTE

- When you are viewing the Content Player app, you cannot configure Picture/Audio settings.



## Playing Back Files on a USB Memory Device/SD Memory Card/Home Network Server (Continue)

### Playing Mode

#### Buttons for playing mode

Buttons	Description
◀◀	The fast revers speed changes every time you press ◀◀.
▶	Play the video
▶▶	The fast forward speed changes every time you press ▶▶.
	Pause the video.
◀◀◀	Go to the previous file.
■	Stop the video.
▶▶▶	Go to the next file.
▲/▼/◀/▶, (ENTER)	Select a desired item.
(Back)	Return to the previous process.
D (yellow)	Display the Manu screen.

### Menu for playing mode

#### Example

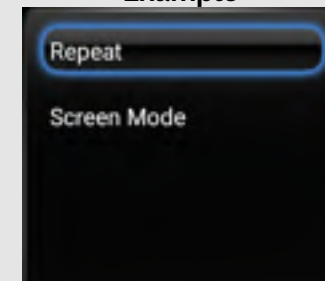

#### Repeat

Configure the repeat playback settings.

**None/Repeat One/Repeat All**

#### Screen Mode

Set the screen size.

**Auto/Original**





## Playing Back Files from a Portable Device

With the remote playback function, you can use your portable device to play back pictures, video, and music on the Home Network server.

### Preparation

Use Wi-Fi to connect the smartphone or tablet to the TV.

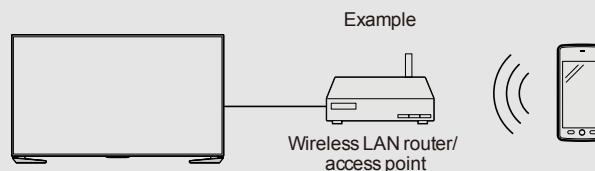

### NOTE

- A wireless access point is required to use a portable device.

- 1 Select "Content Player" from the Devices screen, or launch the Content Player app from HOME screen.
- 2 Press ◀ / ▶ to select "Remote play" icon, and then ● (ENTER).

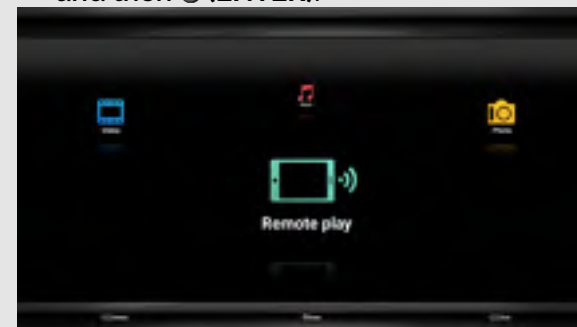

- 3 While the TV is in standby mode, send photos/music/video from the smartphone, tablet, or similar device to the TV.
- To use the remote playback function, your portable device must be a DLNA Certified Digital Media Controller.

### NOTE

- This function will only start when the standby screen of Remote play is displayed after you launch the Content Player app from the HOME screen.
- This function may not work while an Internet application is being used.
- For information on the compatible formats, see "Home Network Server Compatibility" on [page 6-3](#).
- Some Digital Media Controllers and Remote play applications are not supported. In this situation, regardless of whether the file can be played back, the message "Playback not possible" may be displayed, and playback may be stopped.





## Presetting Remote Control Function

You can operate the connected AV products (AV receiver, cable box, SAT tuner, DTV, VCR, BD, DVD, LD) using the presetting manufacturer function of your remote control unit.

### Presetting manufacturer codes

- 1 Press an appropriate button (STB, DVD-VCR or AUDIO) to operate the connected equipment.
- 2 Press an appropriate button (STB, DVD-VCR or AUDIO) and **MANUAL** at the same time to enter the code registration mode.
- 3 Press **0-9** to enter the manufacturer code.
  - Preset mode is finished once the LED no longer lights up.
- 4 After registering the code, the LED will stop blinking then turn off after one second. (If you perform an incorrect operation, the LED will blink quickly then turn off.)

### Manufacturer codes

STB BRAND	REMOTE CONTROL CODE NUMBER
ANVISION	04, 05
CABLE STAR	04, 05
DISH NETWORK	39, 40
DIRECTV	41
EAGLE	05
G.INSTRUMENT	02, 03, 10, 11, 17, 20
GERROLD	17
JERROLD	02, 03, 10, 11, 12, 20, 26-34
MAGNAVOX	04, 05, 08, 12, 15, 16, 18, 19, 22, 23
MOTOROLA	38
OKA SIGMA	07
PANASONIC	14, 21
PHILIPS	04, 05, 08, 13, 15, 16, 18, 19, 22, 23
PIONEER	07
RANDTEK	04, 05
RCA	14, 36*, 37*
S.ATLANTA	01, 09, 24
VIEWSTAR	04, 05, 08, 13, 15, 16, 18, 19, 22, 23
ZENITH	06, 35

### NOTE

- Numbers marked with \* are SAT codes, all others are STB codes.



### Presetting Remote Control Function (Continue)

BD/DVD/LD BRAND	REMOTE CONTROL CODE NUMBER
DENON	24
JVC	31
KENWOOD	36
MAGNAVOX	26
MARANTZ	26
MITSUBISHI	28
PANASONIC	24, 37
PHILIPS	26, 38
PIONEER	30, 33, 35
PROSCAN	25
RCA	25, 39
SAMSUNG	29, 34
SHARP	23, 32, 41, 42
SONY	27, 40
TOSHIBA	26
YAMAHA	24
ZENITH	26

- Depending on the brand, the codes of some BD players may not be supported.

VCR BRAND	REMOTE CONTROL CODE NUMBER
AUDIO DYNAMICS	09
BROCKSONIC	13
CANON	04
CRAIG	12
CURTIS MATHIS	04
DBX	09
EMERSON	10, 13, 14
GE	04
INSTANT REOLYA	04
JC PENNEY	04
JVC	09, 16, 17, 22
KENWOOD	09
MAGNAVOX	04, 05, 06
MAGNIN	12
MEMOREX	04
MONTGOMERY WARD	02
NEC	09
PANASONIC	04, 18, 19, 20, 21
PENTAX	05
PHILCO	04, 05
PHILIPS	04, 05, 06
QUASAR	04
REALISTIC	01, 02
SAMSUNG	11, 12



## Presetting Remote Control Function (Continue)

VCR BRAND	REMOTE CONTROL CODE NUMBER
SHARP	01, 02, 03
SONY	07, 08, 15
SYLVANIA	04, 05, 06
TATUNG	09
TEAC	09
TMK	10
YAMAHA	09

AUDIO BRAND	REMOTE CONTROL CODE NUMBER
SHARP	01
SHARP (SOUND BAR)	02

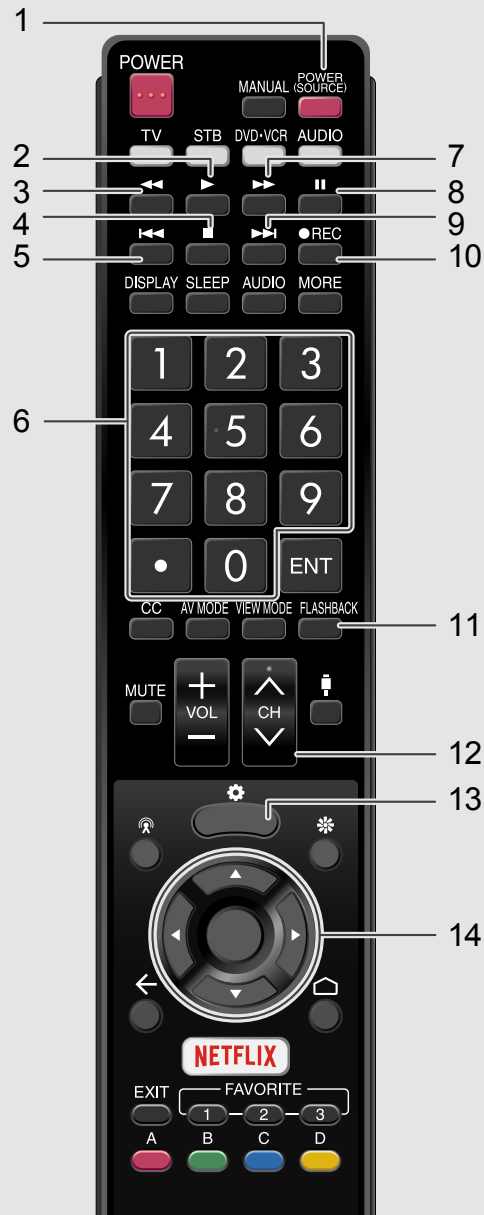

## Operating the Connected Equipment

To operate the connected equipment, press **STB**, **DVD-VCR** or **AUDIO** to select your device. (**STB** (cable/satellite set-top box), **BD**, **DVD**, **VCR** or **AUDIO**.) The remote control unit button will function as follows.

- When you operate **VCR**, **DVD** or **BD**, press

(**Devices**) to select the terminal connected to your device.

- **CABLE** and **SAT** cannot be selected at the same time.
- 1 POWER (SOURCE)**
- Turns the connected equipment power on and off.

- 2 ▶**
- Starts playback. (**VCR**, **BD**, **DVD**)

- 3 ◀◀**
- Rewinds the tape and allows picture search. (**VCR**)
  - Hold down to go in reverse. (**BD**, **DVD**)

- 4 ■**
- Stops the tape transport. (**VCR**)
  - Playback stops when pressed. With some Blu-ray disc/DVD players, pressing the button twice may open the disc tray. (**BD**, **DVD**)

- 5 ◀◀◀**
- Pressing quickly once takes you to the start of the chapter currently playing. Each time you press it, you move back to the start of the previous chapter. (**BD**, **DVD**)

- 6 0-9, . (DOT)**
- Press a button (or buttons) that corresponds to the channel that you wish to watch. (**STB**)

## 7 ▶▶

- Rapidly advances the tape and allows picture search. (**VCR**)
- Hold down to fast forward. (**BD**, **DVD**)

## 8 ■■

- Sets pauses and still pictures. (**VCR**, **BD**, **DVD**)

## 9 ▶▶▶

- Pressing quickly once takes you to the start of the next chapter. Each time you press it, you move ahead to the start of the next chapter. (**BD**, **DVD**)

## 10 ● REC

- Starts recording. (**VCR**)

## 11 FLASHBACK

- Press to switch between the current channel and the channel you were watching immediately before. Some manufacturers do not preset **FLASHBACK**. (**STB**)

## 12 CH ^ / v

- Press **CH ^** or **CH v** to tune in to a higher or lower channel. (**STB**)
- Press to select the channel of the TV tuner on the **VCR**. (**VCR**)

## 13 (TV Setup)

- When this button is pressed, the **BD/DVD** menu will display. (**BD**, **DVD**)

## 14 ▲ / ▼ / ◀ / ▶, ● (ENTER)

- ▲ / ▼ / ◀ / ▶: Press the button to select items on the **STB GUIDE** screen or **STB MENU** screen. (**STB**)
- Press the button to select items on the **BD/DVD** menu screen. (**BD**, **DVD**)
- ● (ENTER): Press to activate the selected function. (**STB**, **BD**, **DVD**)

## Controlling HDMI Equipment Using LINK Operation

### What's LINK Operation?

- Using the HDMI CEC (Consumer Electronics Control) protocol, with LINK Operation you can interactively operate compatible system equipment (Blu-ray disc equipment, AV amplifier, DVD).
- By connecting LINK-compatible devices with HDMI-certified cables to the TV, you can control a recorder or AV amplifier using the remote control of the TV.
- LINK Operation allows you to operate the HDMI-connected equipment with one remote control.

### NOTE

- HDMI IN 1, 2, 3 and 4 terminals are all capable of receiving 4K60P 4:4:4 signals.  
To receive 4K60P 4:4:4 signals, on the Devices menu, set the HDMI type to "Full". (See page 4-1)
- For connecting the TV to LINK-compatible equipment, use commercially available cables.
- Point the remote control toward the TV, not to connected HDMI equipment.
- Video noise may occur depending on the type of HDMI cable used. Make sure to use an HDMI-certified cable.
- Up to 3 pieces of HDMI recording equipment and one AV amplifier can be connected using this system.

### NOTE

- If the equipment does not operate, turn on the equipment and select the appropriate input source using (Devices).
- The LINK feature may not operate properly when an HDMI splitter or AV selector unit is used. These devices may cause interruptions to the image and/or sound.

Connected LINK-compatible devices can be operated without changing the settings of the remote control unit.

### One Touch Play

While the TV is in standby mode, it automatically turns on and plays back the image from the HDMI source.

### Single remote control

The LINK Operation automatically recognizes the connected HDMI device and you can control the TV and the devices as if using a universal remote control.

### Control the LINK-compatible audio system

Set the volume of LINK-compatible audio system.

### NOTE

- The above description is an example of the LINK Operation function.
- Refer to this operation manual and the operation manual of the LINK-compatible device to be used with this TV.

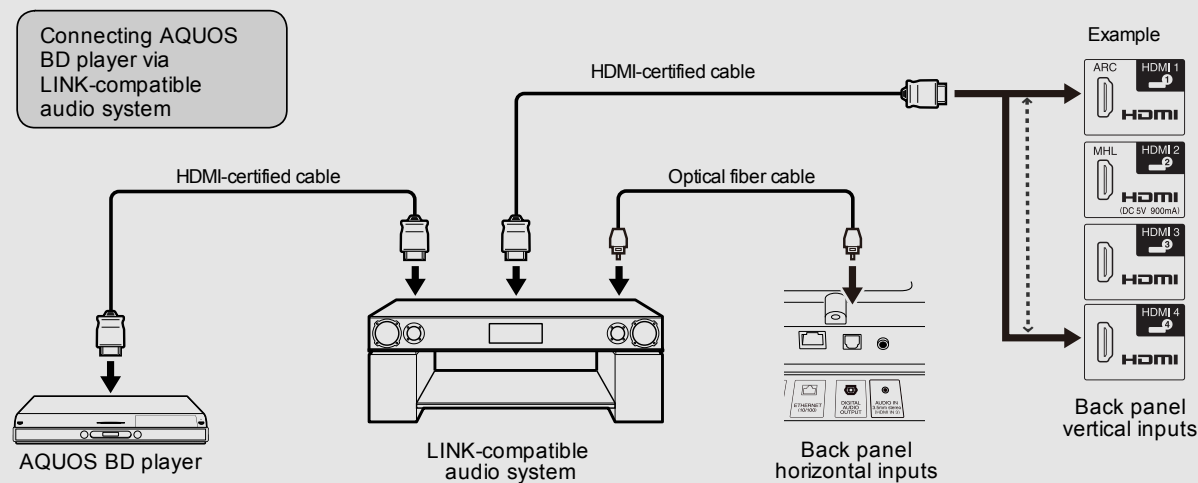

ENG 7-5



## Controlling HDMI Equipment Using LINK Operation (Continue)

### One Touch Playback

LINK Operation allows you to operate the HDMI-connected equipment with one remote control.

Press ► to start playing back a title.

- The last played program is played back. You can use the following buttons during broadcast viewing.

Buttons	Description
<b>POWER (SOURCE)</b>	Turns the power of the HDMI connected devices on and off.
◀◀	Hold down this button to go in reverse.
▶	Starts playback.
▶▶	Hold down this button to fast forward.
■	Stops playback.
	Sets pauses and still pictures.
◀◀◀	Pressing quickly once takes you to the start of the chapter currently playing. Each time you press it, you move back to the start of the previous chapter.
▶▶▶	Pressing quickly once takes you to the start of the next chapter. Each time you press it, you move ahead to the start of the next chapter.

### NOTE

- The buttons ◀◀◀/▶▶▶ do not function with the following Blu-ray disc players currently available.
  - BD-HP20U, BD-HP50U



### Using a Smartphone with the TV

This function enables you to connect the TV to a smartphone that supports Mobile High-Definition Link

(MHL®) using an MHL cable.

To connect the TV to your MHL-compatible smartphone, be sure to use an MHL cable (commercially available).

- You can view pictures and video on a large screen.
- You can play back music files.

#### NOTE

- An MHL-compatible portable device is required to use this function. Connect the device to the HDMI IN 2 terminal.
- This product incorporates MHL 1.
- To use the MHL function, configure the settings from "HOME" > "Settings" > "Device" > "Control".

#### Auto Power On

When an MHL-compatible device is connected to the TV, the TV turns on automatically.

#### Auto Input Selection

When an MHL-compatible device is connected while the TV is on, the input mode is selected automatically.

#### Operation Using the Remote Control

The remote control of the TV can be used to operate a portable device.

- ▲ / ▼ / ◀ / ▶, ● (ENTER), EXIT, 0-9, • (DOT), ENT, etc.
- The operations vary depending on the connected equipment and content being viewed.

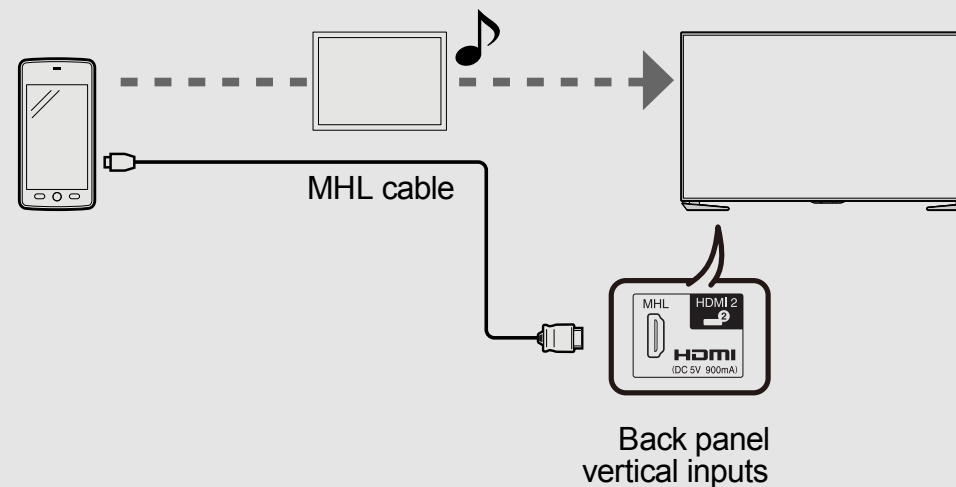

ENG 7-7

## Setting Audio Input

### Audio Select HDMI

This function sets the terminal to output the computer audio. The adjustment items vary depending on the input source. Select the input source corresponding to the terminal connected to the PC and then adjust the desired item.

To perform the operation, refer to "Devices" > "Video in" > "HDMI 3" > "Audio Select".

#### HDMI 3

**HDMI(Digital):** Select this when the TV and PC are connected using an HDMI-certified cable and audio is input via the same cable.

**HDMI+Analog:** Select this when the TV and PC are connected using a HDMI-certified cable and the audio is input via a Ø 3.5 mm stereo minijack.

#### NOTE

- When "Audio Select" is set to "HDMI+Analog", sound will not be produced if you use only an HDMI-certified cable to connect HDMI-compatible equipment. To produce sound, you should make an analog audio connection.
- If you want to connect HDMI-compatible equipment using only an HDMI-certified cable, set "Audio Select" to "HDMI(Digital)".
- "Audio Select" can only be set for the HDMI IN 3.



## Control of the TV

- The TV can be controlled from a PC, control panels and other devices using the RS-232C.
- Use a cross-type RS-232C cable (commercially available) for the connections.

### NOTE

- This operation system should be used by a person who is accustomed to using computers.

## AQUOS Remote Control

Set this function when operating the TV from equipment connected by LAN or wireless LAN. To perform the operation, refer to "TV Setup" > "General".

### Remote Control App

When "Remote Control App" is selected, "Change" will be highlighted. Press ● (ENTER).

### Detailed Settings

Make the detailed settings (Login ID, Password).

Follow the on-screen instructions to configure the settings.

## Device name

Set the name of the TV displayed on other network devices. Configure the settings from "HOME" > "Settings" > "Device" > "About" > "Device name".

## Communication Conditions for RS-232C

Set the RS-232C communication settings on the PC to match the TV's communication conditions.

The TV's communication settings are as follows:

Baud rate:	9,600 bps
Data length:	8 bits
Parity bit:	None
Stop bit:	1 bit
Flow control:	None

### Communication procedure

Send the control commands from the PC via the RS-232C.

The TV operates according to the received command and sends a response message to the PC.

Do not send multiple commands at the same time.

Wait until the PC receives the OK response before sending the next command.

## Control of the TV (Continue)

## Command format

Eight ASCII codes +CR

C1	C2	C3	C4	P1	P2	P3	P4	↵
----	----	----	----	----	----	----	----	---

Command 4-digits

Parameter 4-digits

Return code

Command 4-digits: Command. The text of four characters.

Parameter 4-digits: Parameter 0-9, x, blank, ?

## Parameter

Input the parameter values, aligning left, and fill with blank(s) for the remainder. (Be sure that 4 values are input for the parameter.)

When the input parameter is not within an adjustable range, "ERR" returns. (Refer to "Response code format".)

Any numerical value can replace the "x" on the table.

0			
---	--	--	--

When "?" is input for some commands, the

0	0	0	9
---	---	---	---

present setting

?			
---	--	--	--

value responds.

-	3	0	
---	---	---	--

?	?	?	?
---	---	---	---

## Response code format

Normal response

O	K	↵
---	---	---

Return code (ODH)

Problem response

(communication error or incorrect command)

E	R	R	↵
---	---	---	---

Return code (ODH)

## Command table

- Commands not indicated here are not guaranteed to operate.

CONTROL ITEM		COMMAND				PARAMETER			CONTROL CONTENTS		
POWER SETTING		P	O	W	R	0	-	-	-	Power Off	It shifts to standby.
						1	-	-	-	Power On	Power On
INPUT SELECTION	TOGGLE	I	T	G	D	x	-	-	-	(Toggle)	It input-switches by the toggle. (It is the same as an input change key)
	TV	I	T	V	D	o	-	-	-		It input-switches to TV. (A channel remains as it is. (Last memory))
	1-5	I	A	V	D	*	-	-	-	1: HDMI IN 1, 2: HDMI IN 2, 3: HDMI IN 3, 4: HDMI IN 4, 5: COMPONENT/ VIDEO IN	

## NOTE

- If an underbar (\_) appears in the parameter column, enter a space.
- If an asterisk (\*) appears, enter a value in the range indicated in brackets under CONTROL CONTENTS.
- Any numerical value can replace the "x" on the table.

## Control of the TV (Continue)

CONTROL ITEM	COMMAND				PARAMETER				CONTROL CONTENTS	
	A	V	M	D	*	*	*	-		
AV MODE SELECTION									0: (Toggle), 1: STANDARD, 2: MOVIE, 3: GAME, 4: USER, 5: DYNAMIC (Fixed), 6: DYNAMIC, 7: PC, 17: MOVIE THX (For UH30U model only.)	Although it can choose now, it is toggle operation in inside.
VOLUME	V	O	L	M	*	*	*	-	Volume (0-100)	

CONTROL ITEM	COMMAND				PARAMETER				CONTROL CONTENTS	
	W	I	D	E	*	*	-	-		
VIEW MODE									0: (Toggle), 1: Side Bar, 3: Zoom, 4: Stretch, 8: Dot by Dot, 9: Full Screen, 10: Auto, 11: Original	It is the same as View Mode key.
MUTE	M	U	T	E	*	-	-	-	0: (Toggle), 1: On, 2: Off	

**NOTE**

- If an underbar (\_) appears in the parameter column, enter a space.
- If an asterisk (\*) appears, enter a value in the range indicated in brackets under CONTROL CONTENTS.
- Any numerical value can replace the "x" on the table.

## Control of the TV (Continue)

CONTROL ITEM	COMMAND				PARAMETER				CONTROL CONTENTS
SURROUND	A	C	S	U	*	-	-	-	0: (Toggle), 1: On, 2: Off
AUDIO SELECTION	A	C	H	A	x	-	-	-	(Toggle)
SLEEP TIMER	O	F	T	M	*	-	-	-	0: Off, 1: OFF TIMER - 30 MIN., 2: OFF TIMER - 60 MIN., 3: OFF TIMER - 90 MIN., 4: OFF TIMER - 120 MIN., 5: OFF TIMER - 150 MIN., 6: OFF TIMER - 180 MIN.
EQUALIZER	E	Q	L	Z	*	-	-	-	0: (Toggle), 1: Off, 2: Rock, 3: Pop, 4: Live, 5: Dance, 6: Techno, 7: Classic, 8: Soft

CONTROL ITEM		COMMAND				PARAMETER				CONTROL CONTENTS	
CHANNEL	DIRECT CHANNEL (ANALOG)	D	C	C	H	*	*	*	-	The channel number of TV (1-135)	An input change is included if it is not TV display. In Air, 2-69ch is effective. In Cable, 1-135ch is effective.
	DIRECT CHANNEL (DIGITAL)	D	A	2	P	*	*	*	*	(0100-9999)	DIGITAL Air (Two-Part numbers, 2-digit plus 2-digit)
		D	C	2	U	*	*	*	-	(1-999)	DIGITAL Cable (Two-Part numbers, 3-digit plus 3-digit) Front half of DIGITAL CABLE CHANNEL NO. (Designate major channel)
		D	C	2	L	*	*	*	-	(0-999)	DIGITAL Cable (Two-Part numbers, 3-digit plus 3-digit) Rear half of DIGITAL CABLE CHANNEL NO. (Designate minor channel)

## NOTE

- If an underbar (\_) appears in the parameter column, enter a space.
- If an asterisk (\*) appears, enter a value in the range indicated in brackets under CONTROL CONTENTS.
- Any numerical value can replace the "x" on the table.

## Control of the TV (Continue)

CONTROL ITEM		COMMAND				PARAMETER				CONTROL CONTENTS	
CHANNEL	DIRECT CHANNEL (DIGITAL)	D	C	1	0	*	*	*	*	(0-9999)	DIGITAL Cable (One-Part numbers, 5-digit, less than 10,000)
		D	C	1	1	*	*	*	*	(0-6383)	DIGITAL Cable (One-Part numbers, 5-digit, more than 10,000)
	CH UP	C	H	U	P	x	-	-	-	The channel number of TV +1	If it is not TV display, it will input-switch to TV. (same function as CH ^)
	CH DOWN	C	H	D	W	x	-	-	-	The channel number of TV -1	If it is not TV display, it will input-switch to TV. (same function as CH v)
CC		C	L	C	P	x	-	-	-	(Toggle)	Toggle operation of a closed caption.
DEVICE NAME		T	V	N	M	1	-	-	-		The device name set in "Device Name" is displayed.
MODEL NAME		M	N	R	D	1	-	-	-		The model name of the TV

CONTROL ITEM	COMMAND				PARAMETER				CONTROL CONTENTS	
SOFTWARE VERSION	S	W	V	N	1	-	-	-		The current version of the TV software is displayed.
IP PROTOCOL VERSION	I	P	P	V	1	-	-	-		The currently supported version of IP protocol is displayed.

## NOTE

- If an underbar (\_) appears in the parameter column, enter a space.
- If an asterisk (\*) appears, enter a value in the range indicated in brackets under CONTROL CONTENTS.
- Any numerical value can replace the "x" on the table.

## Control of the TV (Continue)

CONTROL ITEM	COMMAND				PARAMETER				CONTROL CONTENTS
	R	C	K	Y	*	*	-	-	
REMOTE CONTROL BUTTONS									0-9: 0-9, 10: DOT, 11: ENT, 12: POWER, 13: DISPLAY, 14: POWER (SOURCE) 15: ◀◀, 16: ▶, 17: ▶▶, 18: ■■, 19: ◀◀◀, 20: ■, 21: ▶▶■, 22: ● REC, 24: SLEEP, 27: CC, 28: AV MODE, 29: VIEW MODE, 30: FLASHBACK, 31: MUTE, 32: VOL -, 33: VOL +, 34: CH ▲, 35: CH ▼, 36: DEVICES, 38: TV SETUP, 39: HOME, 40: ● (ENTER), 41: ▲, 42: ▼, 43: ◀, 44: ▶, 45: BACK, 46: EXIT, 47: CHANNELS 49: AUDIO, 50: A (red), 51: B (green), 52: C (blue), 53: D (yellow), 55: FAVORITE 1, 56: FAVORITE 2, 57: FAVORITE 3, 59: NETFLIX, 61: MANUAL, 62: MORE, 63: DISCOVER

## NOTE

- If an underbar (\_) appears in the parameter column, enter a space.
- If an asterisk (\*) appears, enter a value in the range indicated in brackets under CONTROL CONTENTS.
- Any numerical value can replace the "x" on the table.

## PC Compatibility Chart

It is necessary to set the PC correctly to display XGA and WXGA signal.

Resolution		Horizontal Frequency	Vertical Frequency	VESA Standard	
VGA	720 x 400	31.5 kHz	70 Hz	—	
	640 x 480	31.5 kHz	60 Hz	○	
		37.9 kHz	72 Hz	○	
SVGA	800 x 600	37.5 kHz	75 Hz	○	
		35.1 kHz	56 Hz	○	
		37.9 kHz	60 Hz	○	
		48.1 kHz	72 Hz	○	
XGA	1024 x 768	46.9 kHz	75 Hz	○	
		48.4 kHz	60 Hz	○	
		56.5 kHz	70 Hz	○	
		60.0 kHz	75 Hz	○	
WXGA	1360 x 768	47.7 kHz	60 Hz	○	
SXGA	1280 x 1024	64.0 kHz	60 Hz	○	
SXGA+	1400 x 1050	65.3 kHz	60 Hz	○	
1080p	1920 x 1080	67.5 kHz	60 Hz	—	
2160p	3840 x 2160	53.95 kHz	24 Hz	—	*1
		56.25 kHz	25 Hz	—	*1
		67.5 kHz	30 Hz	—	*1
		135 kHz	60 Hz	—	*1

VGA and XGA are registered trademarks of International Business Machines Corp.

\*1: When connecting 4K equipment, use HDMI IN 1, 2, 3 or 4 terminal.

### NOTE

- HDMI IN 1, 2, 3 and 4 terminals are all capable of receiving 4K60P 4:4:4 signals.  
To receive 4K60P 4:4:4 signals, on the Devices menu, set the HDMI type to "Full". ([See page 4-1](#))

## Connecting to the Internet

By connecting your TV to a broadband system, you can access the Internet from the TV.

- You can enjoy a variety of streaming content and Internet applications.
- It is necessary to configure the network settings in order to enjoy streaming content and internet applications.

These settings can be configured from "HOME" > "Settings" > "Device" > "Network".

### NOTE

- To connect your TV to the Internet, you must have a broadband Internet connection.
- If you do not have a broadband Internet connection, consult the store where you purchased your TV or ask your Internet service provider or telephone company.
- When an Internet connection is made, an Ethernet and wireless connection cannot be used at the same time. Use only one of the connection types.

### Using an ETHERNET cable

Use an ETHERNET cable (commercially available) to connect the ETHERNET terminal on the TV to your broadband router (commercially available).

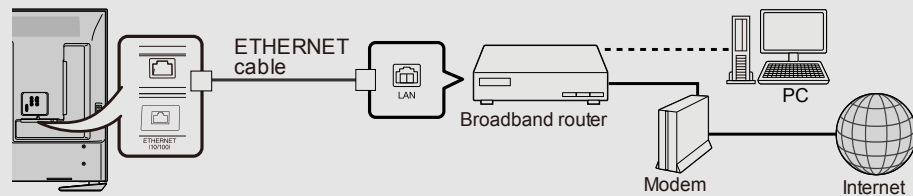

### Using the wireless LAN

This TV is equipped with a wireless LAN function.

For a wireless LAN connection, you must use wireless setup to connect the access point and TV.



### NOTE

- This TV has a built-in wireless LAN function. Using a separate wireless USB LAN adapter may result in radio communications that do not comply with regulations on radio communications. Therefore, do not use a separate wireless LAN adapter.
- A wireless LAN connection and performance cannot be guaranteed for all residential environments. In the following cases, the wireless LAN signal may be poor or drop, or the connection speed may become slower.
  - When used in buildings made with concrete, reinforced steel, or metal
  - When placed near objects that obstruct the signal
  - When used with other wireless devices that emit the same frequency
  - When used in the vicinity of microwave ovens and other devices that emit a magnetic field, electrostatic charge, or electromagnetic interference
- When there is significant interference in the 2.4-GHz frequency (such as from other wireless LAN devices, Bluetooth® devices, 2.4-GHz cordless telephones, and microwave ovens), it is recommended that you use a wireless LAN router/access point that supports IEEE802.11ac (5 GHz) and set the access point to transmit at 5 GHz. For setup details, see the operation manual of your access point.
- Operations cannot be guaranteed when used with access points that do not have Wi-Fi® certification.
- A wireless LAN router/access point is required to connect the TV to the Internet using a wireless LAN. See the operation manual of your access point for setup.
- If your access point is set to a stealth mode (that prevents detection by other devices), you may not be able to establish a connection. In this case, disable the stealth mode on the access point.
- A stable connection speed is required to play back streaming content. Use an Ethernet connection if the wireless LAN speed is unstable.
- Before transferring to a third party or disposal, be sure to initialize the wireless LAN settings.
- Please follow the legislation in your country when using the wireless LAN outdoors.
- If you have failed to connect to the Internet in the above operation, then an error message will appear. In this case, press EXIT to exit from the connected TV feature to make changes to the network settings.
- If you still cannot connect to the Internet, please consult your Internet service provider or telephone company.
- You cannot configure the settings from "HOME" > "Settings" > "Device" > "Network" while using an application. If you must configure your "Network" settings, press the EXIT key to exit the function.





## Using Keyboard and Mouse

You can use a keyboard or mouse for operating the TV when using applications.

- When you use the USB devices, connect the device to the USB terminal on the TV.
- When you use the bluetooth device, make necessary settings with "Bluetooth".

### NOTE

- The keyboard or mouse may not operate properly depending on the application being used.
- The bluetooth device may not operate properly depending on the device being used.

## Notes

**DISCLAIMERS**

- This SHARP device facilitates the access to content and services provided by third parties. The content and services accessible via this device belong to and may be proprietary to third parties. Therefore, any use of such third party content and services must be in accordance with any authorization or terms of use provided by such content or service provider. SHARP shall not be liable to you or any third party for your failure to abide by such authorization or terms of use. Unless otherwise specifically authorized by the applicable content or service provider, all third party content and services provided are for personal and non-commercial use; you may not modify, copy, distribute, transmit, display, perform, reproduce, upload, publish, license, create derivative works from, transfer or sell in any manner or medium any content or services available via this device.
- SHARP is not responsible, nor liable, for customer service-related issues related to the third party content or services. Any questions, comments or service-related inquiries relating to the third party content or service should be made directly to the applicable content or service provider. You may not be able to access content or services from the device for a variety of reasons which may be unrelated to the device itself, including, but not limited to, power failure, other Internet connection, or failure to configure your device properly. SHARP, its directors, officers, employees, agents, contractors and affiliates shall not be liable to you or any third party with respect to such failures or maintenance outages, regardless of cause or whether or not it could have been avoided.
- ALL THIRD PARTY CONTENT OR SERVICES ACCESSIBLE VIA THIS DEVICE IS PROVIDED TO YOU ON AN "AS-IS" AND "AS AVAILABLE" BASIS AND SHARP AND ITS AFFILIATES MAKE NO WARRANTY OR REPRESENTATION OF ANY KIND TO YOU, EITHER EXPRESS OR IMPLIED, INCLUDING, WITHOUT LIMITATION, ANY WARRANTIES OF MERCHANTABILITY, NON-INFRINGEMENT, FITNESS FOR A PARTICULAR PURPOSE OR ANY WARRANTIES OF SUITABILITY, AVAILABILITY, ACCURACY, COMPLETENESS, SECURITY, TITLE, USEFULNESS, LACK OF NEGLIGENCE OR ERROR-FREE OR UNINTERRUPTED OPERATION OR USE OF THE CONTENT OR SERVICES PROVIDED TO YOU OR THAT THE CONTENT OR SERVICES WILL MEET YOUR REQUIREMENTS OR EXPECTATIONS.
- SHARP IS NOT AN AGENT OF AND ASSUMES NO RESPONSIBILITY FOR THE ACTS OR OMISSIONS OF THIRD PARTY CONTENT OR SERVICE PROVIDERS, NOR ANY ASPECT OF THE CONTENT OR SERVICE RELATED TO SUCH THIRD PARTY PROVIDERS.
- IN NO EVENT WILL SHARP AND/OR ITS AFFILIATES BE LIABLE TO YOU OR ANY THIRD PARTY FOR ANY DIRECT, INDIRECT, SPECIAL, INCIDENTAL, PUNITIVE, CONSEQUENTIAL OR OTHER DAMAGES, WHETHER THE THEORY OF LIABILITY IS BASED ON CONTRACT, TORT, NEGLIGENCE, BREACH OF WARRANTY, STRICT LIABILITY OR OTHERWISE AND WHETHER OR NOT SHARP AND/OR ITS AFFILIATES HAVE BEEN ADVISED OF THE POSSIBILITY OF SUCH DAMAGES.

## Troubleshooting

Problem	Possible Solution
<ul style="list-style-type: none"> <li>No power</li> </ul>	<ul style="list-style-type: none"> <li>Check if you pressed <b>POWER</b> on the remote control unit.</li> <li>Is the AC cord disconnected?</li> <li>Has the power been turned on?</li> </ul>
<ul style="list-style-type: none"> <li>Unit cannot be operated.</li> </ul>	<ul style="list-style-type: none"> <li>External influences such as lightning, static electricity, may cause improper operation. In this case, operate the unit after first turning off the power of the TV or unplugging the AC cord and replugging it in after 1 or 2 minutes.</li> </ul>
<ul style="list-style-type: none"> <li>Remote control unit does not operate.</li> </ul>	<ul style="list-style-type: none"> <li>Is the equipment to be operated by the remote control unit set correctly? Press <b>TV</b> to set the remote control unit to the setting for operating the TV.</li> <li>Are batteries inserted with polarity (+, -) aligned?</li> <li>Are batteries worn out? (Replace with new batteries.)</li> <li>Are you using it under strong or fluorescent lighting?</li> <li>Is a fluorescent light illuminated near the remote control sensor?</li> <li>Is "RC Control Lock" selected in "Operation Lock Out"? <a href="#">Page 3-41</a></li> <li>If you are using a touchpad remote control unit, has the pairing operation finished? <a href="#">page 2-2</a></li> </ul>
<ul style="list-style-type: none"> <li>Picture is cut off/with sidebar screen.</li> </ul>	<ul style="list-style-type: none"> <li>Are screen mode adjustments such as picture size made correctly? <a href="#">Pages 5-10 to 5-12</a></li> </ul>
<ul style="list-style-type: none"> <li>Strange color, light color, or color misalignment</li> </ul>	<ul style="list-style-type: none"> <li>Adjust the picture tone. <a href="#">Pages 3-2 to 3-23</a></li> <li>Is the room too bright? The picture may look dark in a room that is too bright.</li> </ul>
<ul style="list-style-type: none"> <li>Power is suddenly turned off.</li> </ul>	<ul style="list-style-type: none"> <li>Is the sleep timer set? <a href="#">Pages 5-7</a></li> <li>Check the power control settings. <a href="#">Page 2-6</a></li> <li>The unit's internal temperature has increased. Remove any objects blocking vent or clean.</li> </ul>

Problem	Possible Solution
<ul style="list-style-type: none"> <li>No picture</li> </ul>	<ul style="list-style-type: none"> <li>Is connection to other components correct?</li> <li>Is the correct input selected? <a href="#">Pages 2-9</a></li> <li>Is "On" selected in "Audio Only"? <a href="#">Page 5-13</a></li> <li>If the PC image is not displayed, check the following: <ul style="list-style-type: none"> <li>When connecting a laptop PC to the TV, check that display output mode of the PC is set to external monitor.</li> <li>Check the resolution setting on the PC. Is a non-compatible signal being input? <a href="#">Page 8-8</a></li> </ul> </li> <li>For 4K60P signals applied to an HDMI input, the external device may not be outputting signals correctly. Set "HDMI Type Selection" to "Limited". <a href="#">page 4-1</a></li> </ul>
<ul style="list-style-type: none"> <li>Picture quality of HD programs is poor.</li> </ul>	<ul style="list-style-type: none"> <li>To enjoy HD images from external equipment, you are required to set up HDMI connection or component connection.</li> <li>If the program content is not of HD quality, HD images cannot be displayed. Check that the program you are viewing provides HD images.</li> <li>The HD cable/satellite set-top box may need to be configured to output HD images via cable/satellite.</li> <li>The cable/satellite broadcast may not support a signal resolution of 1080p.</li> </ul>
<ul style="list-style-type: none"> <li>The TV sometimes makes a cracking sound.</li> </ul>	<ul style="list-style-type: none"> <li>This is not a malfunction. This happens when the cabinet slightly expands and contracts according to change in temperature. This does not affect the TV's performance.</li> </ul>

## Troubleshooting (Continue)

Problem	Possible Solution
<ul style="list-style-type: none"> <li>No sound</li> </ul>	<ul style="list-style-type: none"> <li>Is connection to other components correct?</li> <li>Is the volume too low? <a href="#">Page 5-2</a></li> <li>Is "Variable" selected in "Output Select"? <a href="#">Page 4-4</a></li> <li>Have you pressed MUTE on the remote control unit? <a href="#">Page 5-3</a></li> <li>Check the audio output of the connected external equipment. Is the volume too low or muted?</li> <li>When external equipment is connected via an HDMI cable, you may need to configure the audio to be output through the HDMI cable.</li> <li>When audio is not output from external equipment connected to the HDMI IN 3 terminal, check the "Audio Select" setting. <a href="#">Page 8-1</a></li> <li>Even when external equipment is connected using an HDMI-certified cable, an audio cable connection may be required depending on the type of equipment and the media being played back. In this case, in addition to connecting an HDMI-certified cable to the HDMI IN 3 terminal, connect a Ø 3.5 mm stereo minijack cable to the AUDIO IN terminal and set "Audio Select" to "HDMI+Analog". <a href="#">Page 8-1</a></li> <li>When connecting a PC via an HDMI-certified cable, check the following: <ul style="list-style-type: none"> <li>Is the audio output of the PC configured correctly? Check the audio output settings and output audio format in Sound Properties on the PC. The audio formats compatible with this TV are PCM, Dolby Digital. With other formats, audio cannot be output.</li> <li>Depending on the board, only video signals may be output. In this case, in addition to connecting an HDMI-certified cable to the HDMI IN 3 terminal, connect a Ø 3.5 mm stereo minijack cable to the AUDIO IN terminal and set "Audio Select" to "HDMI+Analog". <a href="#">Page 8-1</a></li> </ul> </li> <li>If you have selected "Bluetooth-Audio", you will not be able to output sound from the TV's internal speakers or to output optical audio.</li> </ul>

Problem	Possible Solution
<ul style="list-style-type: none"> <li>Google Cast image/ audio cannot be output to the TV.</li> </ul>	<ul style="list-style-type: none"> <li>Check pairing.</li> </ul>

**Troubleshooting - Error Message**

<b>The example of an error message displayed on a screen</b>	<b>Possible Solution</b>
<ul style="list-style-type: none"><li>• No broadcast now.</li></ul>	<ul style="list-style-type: none"><li>• Check the antenna cable. Check that the antenna is correctly setup.</li><li>• Check the broadcast time in the program guide.</li></ul>
<ul style="list-style-type: none"><li>• An incompatible audio signal has been received. Check the output device settings.</li></ul>	<ul style="list-style-type: none"><li>• This message is displayed when an audio format other than PCM, Dolby Digital is input.<ul style="list-style-type: none"><li>- Set the audio output format of connected external HDMI equipment to PCM, Dolby Digital.</li><li>- Refer to the operation manual of the external equipment for setting details.</li></ul></li></ul>

## Information on the Software License for This Product

### Software License

You can read the software licenses in the on-screen display menu. Refer to "HOME" > "Settings" > "Device" > "About" > "Legal information" > "Open source licenses" .

### Software composition

The software included in this product is comprised of various software components whose individual copyrights are held by SHARP or by third parties.

#### Cautions regarding use in high and low temperature environments

- When the unit is used in a low temperature space (e.g. room, office), the picture may leave trails or appear slightly delayed. This is not a malfunction, and the unit will recover when the temperature returns to normal.
- Do not leave the unit in a hot or cold location. Also, do not leave the unit in a location exposed to direct sunlight or near a heater, as this may cause the cabinet to deform and the front panel to malfunction.

Storage temperature: -4°F to +140°F (-20°C to +60°C)

- Google, Android, Android TV, Google Play, Google Cast, and YouTube are trademarks of Google Inc.

- Dolby, Dolby Audio, and the double-D symbol are trademarks of Dolby Laboratories.

- The terms HDMI and HDMI High-Definition Multimedia Interface, and the HDMI Logo are trademarks or registered trademarks of HDMI Licensing, LLC in the United States and other countries.

- The Wi-Fi CERTIFIED Logo is a certification mark of the Wi-Fi Alliance.
- The Wi-Fi Protected Setup Mark is a mark of the Wi-Fi Alliance.

- Netflix and the Netflix logo are the registered trademarks of Netflix, Inc.

- VUDU™ is a trademark of VUDU, Inc.

- SDHC Logo is a trademark of SD-3C, LLC.

- MHL, the MHL Logo, and Mobile High-Definition Link are trademarks or registered trademarks of MHL LLC in the United States and other countries.
- MHL®

- The Bluetooth® word mark and logos are registered trademarks owned by Bluetooth SIG, Inc. and any use of such marks by SHARP Corporation is under license. Other trademarks and trade names are those of their respective owners.

- THX and the THX logo are trademarks of THX Ltd., registered in the United States and other jurisdictions. All rights reserved.

- For DTS patents, see <http://patents.dts.com>. Manufactured under license from DTS Licensing Limited. DTS, the Symbol, & DTS and the Symbol together are registered trademarks, and DTS 2.0+Digital Out is a trademark of DTS, Inc. © DTS, Inc. All Rights Reserved.

TV		Model: LC-80UH30U		
LCD panel	Size	80" Class (80" Diagonal)		
	Resolution	8,294,400 pixels (3,840 x 2,160)		
TV Function	TV-standard (CCIR)	American TV Standard ATSC/NTSC System		
	Receiving Channel	VHF/UHF	VHF 2-13ch, UHF 14-69ch	
		CATV	1-135ch (non-scrambled channel only)	
		Digital Terrestrial Broadcast (8VSB)	2-69ch	
		Digital cable*1 (64/256 QAM)	1-135ch (non-scrambled channel only)	
Audio multiplex	BTSC System			
Audio out	10W x 2 + 15W(WF)			
Terminals	Side	SD card slot	SD/SDHC memory card *2	
		Back panel vertical side	HDMI IN 1	HDMI in with HDCP (HDCP 2.2 supported), ARC
			HDMI IN 2	HDMI in with HDCP (HDCP 2.2 supported), MHL
			HDMI IN 3	HDMI in with HDCP (HDCP 2.2 supported), Audio in (ø3.5 mm stereo jack)
			HDMI IN 4	HDMI in with HDCP (HDCP 2.2 supported)
			AUDIO OUT	Audio out (ø3.5 mm stereo jack)
		USB 1	Photo/Music/Video mode, Software update, USB keyboard/mouse	
	Back panel surface side	COMPONENT IN/VIDEO IN	COMPONENT in/AV in	
		RS-232C	9-pin D-sub male connector	
		USB 4	USB connector type B (Not for customers)	
	Back panel horizontal side	ANT/CABLE	75Ω Unbalance, F Type x 1 for Analog (VHF/UHF/CATV) and Digital (AIR/CABLE)	
		AUDIO IN	Audio in (ø3.5mm stereo jack)	
		DIGITAL AUDIO OUT	Optical Digital audio out x 1 (PCM/Dolby Digital)	
		ETHERNET	Network connector	
		USB 2	Photo/Music/Video mode, Software update, USB keyboard/mouse	
		USB 3	Photo/Music/Video mode, Software update, USB keyboard/mouse	
OSD language	English/French/Spanish			
Power Requirement	AC 120 V, 60Hz			
On Mode Power	223 W			
Power Consumption	468 W (0.5 W Standby with AC 120 V)			
Weight	TV + Stand	122.4lbs/55.5kg		
	TV only	113.5lbs/51.5kg		
Dimensions (W x H x D)(inch)	TV + Stand	71 1/2 x 43 x 17 59/64		
	TV only	71 1/2 x 41 35/64 x 4 1/2		
Operating temperature	+32°F to +104°F (0°C to +40°C)			

\*1 Emergency alert messages via Cable are unreceivable.

\*2 If you insert any card other than the SD/SDHC (class 6 or higher), it will not work.

- As part of policy of continuous improvement, SHARP reserves the right to make design and specification changed for product improvement without prior notice.
- The performance specification figures indicated are nominal values of production units. There may be some deviations from these values in individual units.



## TV (Continue)

Item		Model: LC-70UH30U	
LCD panel	Size	70" Class (69 1/2" Diagonal)	
	Resolution	8,294,400 pixels (3,840 x 2,160)	
TV Function	TV-standard (CCIR)	American TV Standard ATSC/NTSC System	
	Receiving Channel	VHF/UHF	VHF 2-13ch, UHF 14-69ch
		CATV	1-135ch (non-scrambled channel only)
		Digital Terrestrial Broadcast (8VSB)	2-69ch
		Digital cable*1 (64/256 QAM)	1-135ch (non-scrambled channel only)
Audio multiplex	BTSC System		
Audio out	10W x 2 + 15W(WF)		
Terminals	Side	SD card slot	SD/SDHC memory card *2
		Back panel vertical side	HDMI IN 1
	HDMI IN 2		HDMI in with HDCP (HDCP 2.2 supported), MHL
	HDMI IN 3		HDMI in with HDCP (HDCP 2.2 supported), Audio in (ø3.5 mm stereo jack)
	HDMI IN 4		HDMI in with HDCP (HDCP 2.2 supported)
	AUDIO OUT		Audio out (ø3.5 mm stereo jack)
	USB 1		Photo/Music/Video mode, Software update, USB keyboard/mouse
	Back panel surface side	COMPONENT IN/VIDEO IN	COMPONENT in/AV in
		RS-232C	9-pin D-sub male connector
		USB 4	USB connector type B (Not for customers)
	Back panel horizontal side	ANT/CABLE	75Ω Unbalance, F Type x 1 for Analog (VHF/UHF/CATV) and Digital (AIR/CABLE)
		AUDIO IN	Audio in (ø3.5mm stereo jack)
		DIGITAL AUDIO OUT	Optical Digital audio out x 1 (PCM/Dolby Digital)
		ETHERNET	Network connector
		USB 2	Photo/Music/Video mode, Software update, USB keyboard/mouse
		USB 3	Photo/Music/Video mode, Software update, USB keyboard/mouse
OSD language	English/French/Spanish		
Power Requirement	AC 120 V, 60Hz		
On Mode Power	125 W		
Power Consumption	270 W (0.5 W Standby with AC 120 V)		
Weight	TV + Stand	86.0lbs/39.0kg	
	TV only	81.6lbs/37.0kg	
Dimensions (W x H x D)(inch)	TV + Stand	61 35/64 x 37 3/32 x 14 39/64	
	TV only	61 35/64 x 35 3/4 x 3 15/32	
Operating temperature	+32°F to +104°F (0°C to +40°C)		

\*1 Emergency alert messages via Cable are unreceivable.

\*2 If you insert any card other than the SD/SDHC (class 6 or higher), it will not work.

- As part of policy of continuous improvement, SHARP reserves the right to make design and specification changed for product improvement without prior notice.
- The performance specification figures indicated are nominal values of production units. There may be some deviations from these values in individual units.

## TV (Continue)

Item		Model: LC-80UE30U	
LCD panel	Size	80" Class (80" Diagonal)	
	Resolution	8,294,400 pixels (3,840 x 2,160)	
TV Function	TV-standard (CCIR)	American TV Standard ATSC/NTSC System	
	Receiving Channel	VHF/UHF	VHF 2-13ch, UHF 14-69ch
		CATV	1-135ch (non-scrambled channel only)
		Digital Terrestrial Broadcast (8VSB)	2-69ch
		Digital cable*1 (64/256 QAM)	1-135ch (non-scrambled channel only)
Audio multiplex	BTSC System		
Audio out		10W x 2	
Terminals	Back panel vertical side	HDMI IN 1	HDMI in with HDCP (HDCP 2.2 supported), ARC
		HDMI IN 2	HDMI in with HDCP (HDCP 2.2 supported), MHL
		HDMI IN 3	HDMI in with HDCP (HDCP 2.2 supported), Audio in (ø3.5 mm stereo jack)
		HDMI IN 4	HDMI in with HDCP (HDCP 2.2 supported)
		AUDIO OUT	Audio out (ø3.5 mm stereo jack)
		USB 1	Photo/Music/Video mode, Software update, USB keyboard/mouse
	Back panel surface side	COMPONENT IN/VIDEO IN	COMPONENT in/AV in
		RS-232C	9-pin D-sub male connector
		USB 4	USB connector type B (Not for customers)
	Back panel horizontal side	ANT/CABLE	75Ω Unbalance, F Type x 1 for Analog (VHF/UHF/CATV) and Digital (AIR/CABLE)
		AUDIO IN	Audio in (ø3.5mm stereo jack)
		DIGITAL AUDIO OUT	Optical Digital audio out x 1 (PCM/Dolby Digital)
		ETHERNET	Network connector
		USB 2	Photo/Music/Video mode, Software update, USB keyboard/mouse
		USB 3	Photo/Music/Video mode, Software update, USB keyboard/mouse
OSD language		English/French/Spanish	
Power Requirement		AC 120 V, 60Hz	
On Mode Power		223 W	
Power Consumption		468 W (0.5 W Standby with AC 120 V)	
Weight	TV + Stand	121.3lbs/55.0kg	
	TV only	112.4lbs/51.0kg	
Dimensions (W x H x D)(inch)	TV + Stand	71 1/2 x 43 x 17 59/64	
	TV only	71 1/2 x 41 35/64 x 4 1/2	
Operating temperature		+32°F to +104°F (0°C to +40°C)	

\*1 Emergency alert messages via Cable are unreceivable.

- As part of policy of continuous improvement, SHARP reserves the right to make design and specification changed for product improvement without prior notice.
- The performance specification figures indicated are nominal values of production units. There may be some deviations from these values in individual units.

## TV (Continue)

Item		Model: LC-70UE30U/LC-70UC30U	
LCD panel	Size	70" Class (69 1/2" Diagonal)	
	Resolution	8,294,400 pixels (3,840 x 2,160)	
TV Function	TV-standard (CCIR)	American TV Standard ATSC/NTSC System	
	Receiving Channel	VHF/UHF	VHF 2-13ch, UHF 14-69ch
		CATV	1-135ch (non-scrambled channel only)
		Digital Terrestrial Broadcast (8VSB)	2-69ch
		Digital cable*1 (64/256 QAM)	1-135ch (non-scrambled channel only)
Audio multiplex	BTSC System		
Audio out		10W x 2	
Terminals	Back panel vertical side	HDMI IN 1	HDMI in with HDCP (HDCP 2.2 supported), ARC
		HDMI IN 2	HDMI in with HDCP (HDCP 2.2 supported), MHL
		HDMI IN 3	HDMI in with HDCP (HDCP 2.2 supported), Audio in (ø3.5 mm stereo jack)
		HDMI IN 4	HDMI in with HDCP (HDCP 2.2 supported)
		AUDIO OUT	Audio out (ø3.5 mm stereo jack)
		USB 1	Photo/Music/Video mode, Software update, USB keyboard/mouse
	Back panel surface side	COMPONENT IN/VIDEO IN	COMPONENT in/AV in
		RS-232C	9-pin D-sub male connector
		USB 4	USB connector type B (Not for customers)
	Back panel horizontal side	ANT/CABLE	75Ω Unbalance, F Type x 1 for Analog (VHF/UHF/CATV) and Digital (AIR/CABLE)
		AUDIO IN	Audio in (ø3.5mm stereo jack)
		DIGITAL AUDIO OUT	Optical Digital audio out x 1 (PCM/Dolby Digital)
		ETHERNET	Network connector
		USB 2	Photo/Music/Video mode, Software update, USB keyboard/mouse
		USB 3	Photo/Music/Video mode, Software update, USB keyboard/mouse
OSD language		English/French/Spanish	
Power Requirement		AC 120 V, 60Hz	
On Mode Power		125 W	
Power Consumption		270 W (0.5 W Standby with AC 120 V)	
Weight	TV + Stand	84.9lbs/38.5kg	
	TV only	80.5lbs/36.5kg	
Dimensions (W x H x D)(inch)	TV + Stand	61 35/64 x 37 3/32 x 14 39/64	
	TV only	61 35/64 x 35 3/4 x 3 15/32	
Operating temperature		+32°F to +104°F (0°C to +40°C)	

\*1 Emergency alert messages via Cable are unreceivable.

- As part of policy of continuous improvement, SHARP reserves the right to make design and specification changed for product improvement without prior notice.
- The performance specification figures indicated are nominal values of production units. There may be some deviations from these values in individual units.

## TV (Continue)

Item		Model: LC-60UE30U	
LCD panel	Size	60" Class (60 3/32" Diagonal)	
	Resolution	8,294,400 pixels (3,840 x 2,160)	
TV Function	TV-standard (CCIR)	American TV Standard ATSC/NTSC System	
	Receiving Channel	VHF/UHF	VHF 2-13ch, UHF 14-69ch
		CATV	1-135ch (non-scrambled channel only)
		Digital Terrestrial Broadcast (8VSB)	2-69ch
		Digital cable*1 (64/256 QAM)	1-135ch (non-scrambled channel only)
Audio multiplex	BTSC System		
Audio out		10W x 2	
Terminals	Back panel vertical side	HDMI IN 1	HDMI in with HDCP (HDCP 2.2 supported), ARC
		HDMI IN 2	HDMI in with HDCP (HDCP 2.2 supported), MHL
		HDMI IN 3	HDMI in with HDCP (HDCP 2.2 supported), Audio in (ø3.5 mm stereo jack)
		HDMI IN 4	HDMI in with HDCP (HDCP 2.2 supported)
		AUDIO OUT	Audio out (ø3.5 mm stereo jack)
		USB 1	Photo/Music/Video mode, Software update, USB keyboard/mouse
	Back panel surface side	COMPONENT IN/VIDEO IN	COMPONENT in/AV in
		RS-232C	9-pin D-sub male connector
		USB 4	USB connector type B (Not for customers)
	Back panel horizontal side	ANT/CABLE	75Ω Unbalance, F Type x 1 for Analog (VHF/UHF/CATV) and Digital (AIR/CABLE)
		AUDIO IN	Audio in (ø3.5mm stereo jack)
		DIGITAL AUDIO OUT	Optical Digital audio out x 1 (PCM/Dolby Digital)
		ETHERNET	Network connector
		USB 2	Photo/Music/Video mode, Software update, USB keyboard/mouse
		USB 3	Photo/Music/Video mode, Software update, USB keyboard/mouse
OSD language		English/French/Spanish	
Power Requirement		AC 120 V, 60Hz	
On Mode Power		125 W	
Power Consumption		235 W (0.5 W Standby with AC 120 V)	
Weight	TV + Stand	63.9lbs/29.0kg	
	TV only	59.5lbs/27.0kg	
Dimensions (W x H x D)(inch)	TV + Stand	53 23/64 x 32 29/64 x 14 39/64	
	TV only	53 23/64 x 31 5/32 x 3 25/64	
Operating temperature		+32°F to +104°F (0°C to +40°C)	

\*1 Emergency alert messages via Cable are unreceivable.

- As part of policy of continuous improvement, SHARP reserves the right to make design and specification changed for product improvement without prior notice.
- The performance specification figures indicated are nominal values of production units. There may be some deviations from these values in individual units.

## Wireless LAN

Specification	
Standard	IEEE 802.11a/b/g/n/ac*
Frequency Band	2412-2484 MHz 5150-5850 MHz
Security	Static WEP (64/128 bit key index 1 only) WPA-PSK (TKIP) WPA2-PSK (AES)
Modulation	IEEE802.11b: DBPSK, DQPSK, CCK / DSSS HRDSSS IEEE802.11a: BPSK, QPSK, 16QAM, DBPSK, DQPSK, CCK / OFDM IEEE802.11g: BPSK, QPSK, 16QAM, DBPSK, DQPSK, CCK, PBCC / OFDM IEEE802.11n: BPSK, QPSK, 16QAM, 64QAM / OFDM IEEE802.11ac: BPSK, QPSK, 16QAM, 64QAM, 256QAM / OFDM
Throughput	IEEE802.11b: 1, 2.5, 5, 11Mbps IEEE802.11a: 6, 9, 12, 18, 24, 36, 48, 54Mbps IEEE802.11g: 6, 9, 12, 18, 24, 36, 48, 54Mbps IEEE802.11n: ~300Mbps IEEE802.11ac: ~866.6Mbps

\* IEEE 802.11ac is supported.

## LC-80UH30U

Unit: inch (mm)  
 Unite: pouce (mm)  
 Unidad: pulgada (mm)

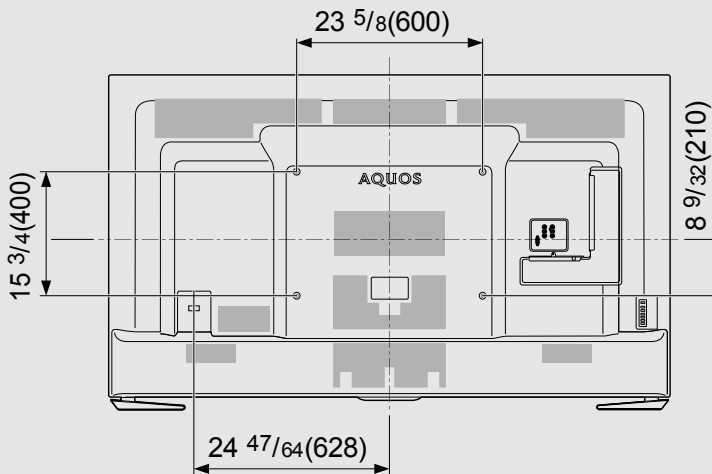
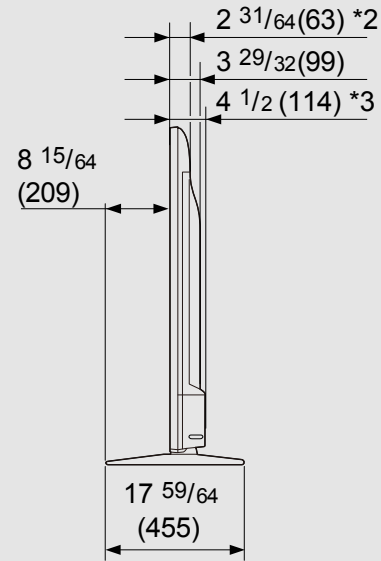
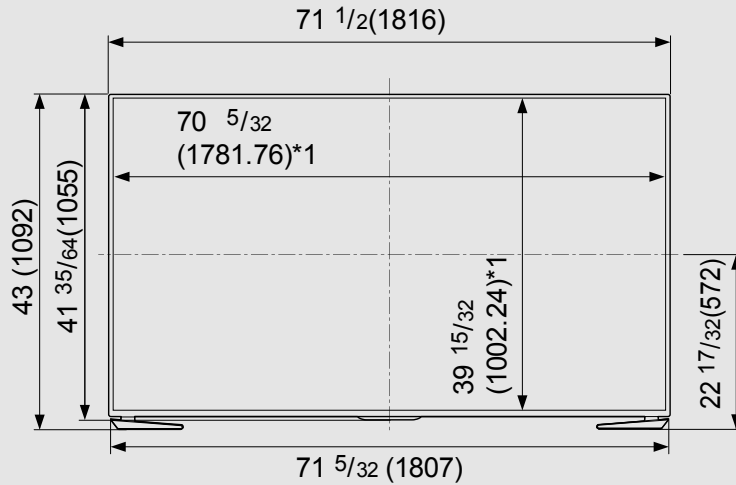

\*1 Active area/Area activa/Zone active  
 \*2 Thinnest part/Parte mas delgada/Partie la plus mince  
 \*3 Including projecting parts/Incluyendo partes salientes/Parties saillantes incluses

## LC-70UH30U

Unit: inch (mm)  
 Unite: pouce (mm)  
 Unidad: pulgada (mm)

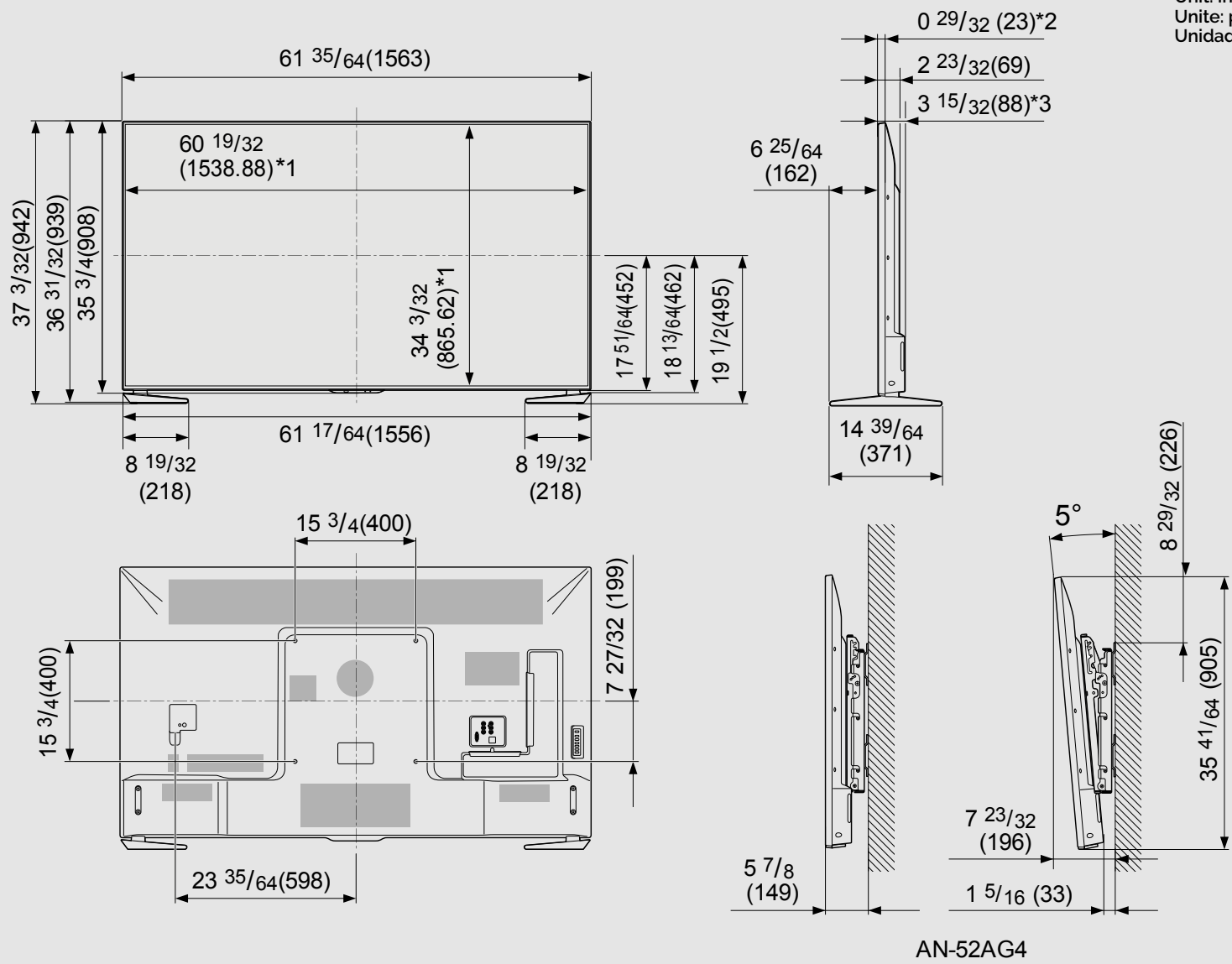

\*1 Active area/Area activa/Zone active  
 \*2 Thinnest part/Parte mas delgada/Partie la plus mince  
 \*3 Including projecting parts/Incluyendo partes salientes/Parties saillantes incluses



## LC-80UE30U

Unit: inch (mm)  
 Unite: pouce (mm)  
 Unidad: pulgada (mm)

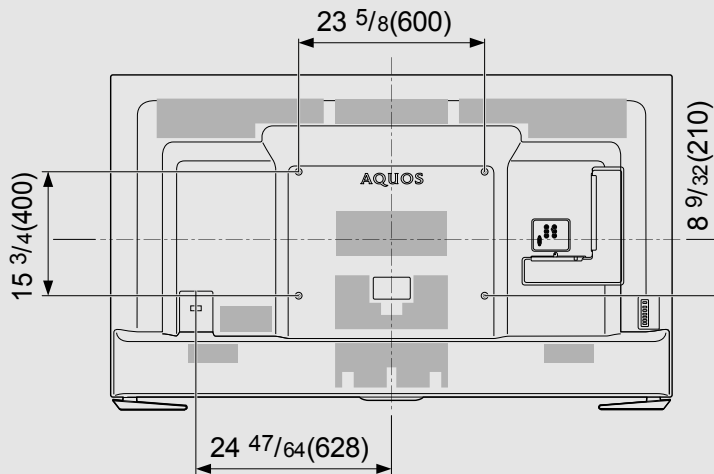
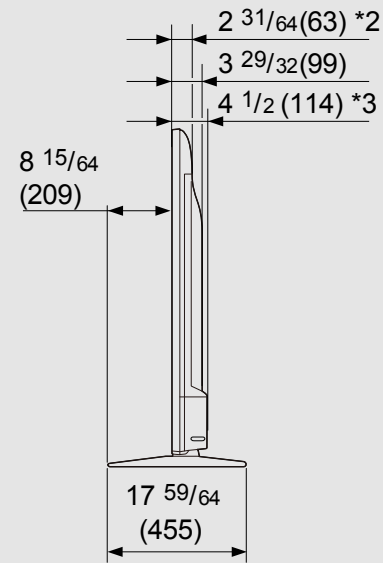
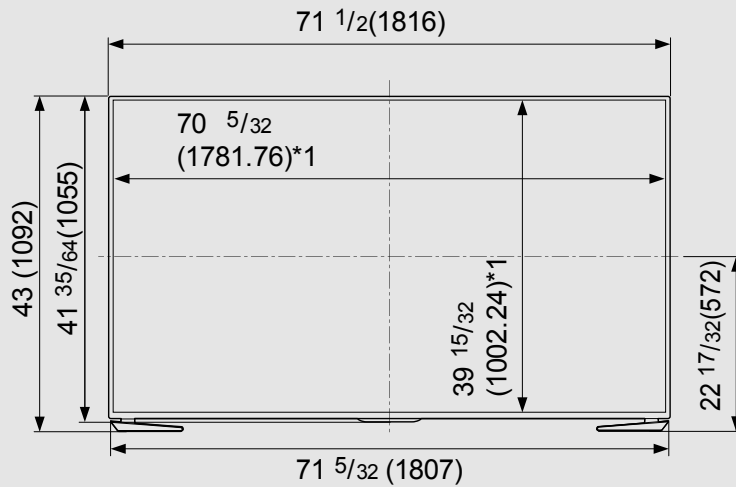

\*1 Active area/Area activa/Zone active  
 \*2 Thinnest part/Parte mas delgada/Partie la plus mince  
 \*3 Including projecting parts/Incluyendo partes salientes/Parties saillantes incluses



## LC-70UE30U / LC-70UC30U

Unit: inch (mm)  
 Unite: pouce (mm)  
 Unidad: pulgada (mm)

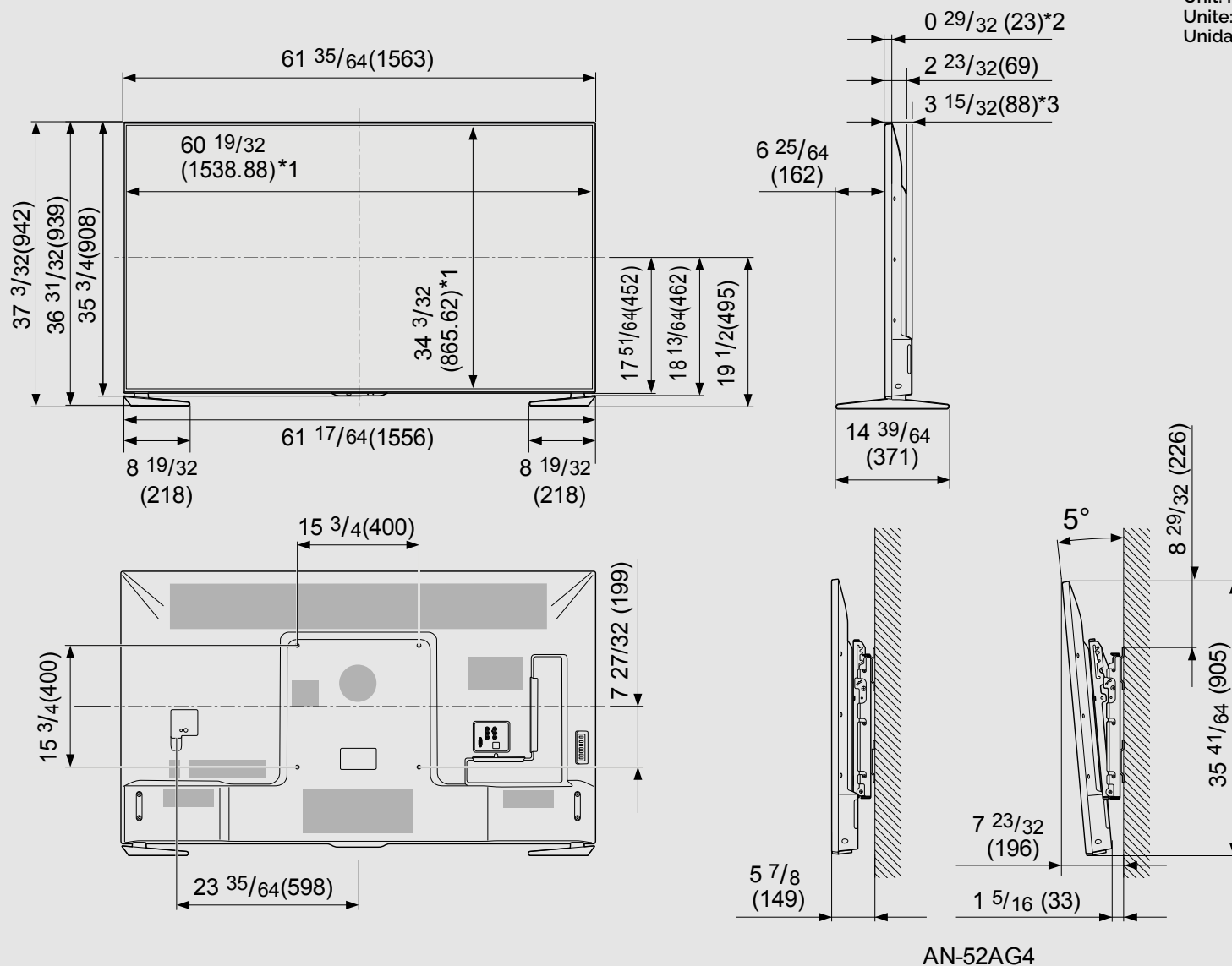

\*1 Active area/Area activa/Zone active  
 \*2 Thinnest part/Parte mas delgada/Partie la plus mince  
 \*3 Including projecting parts/Incluyendo partes salientes/Parties saillantes incluses

## LC-60UE30U

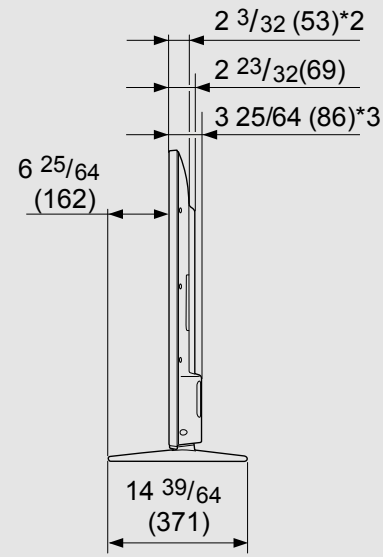
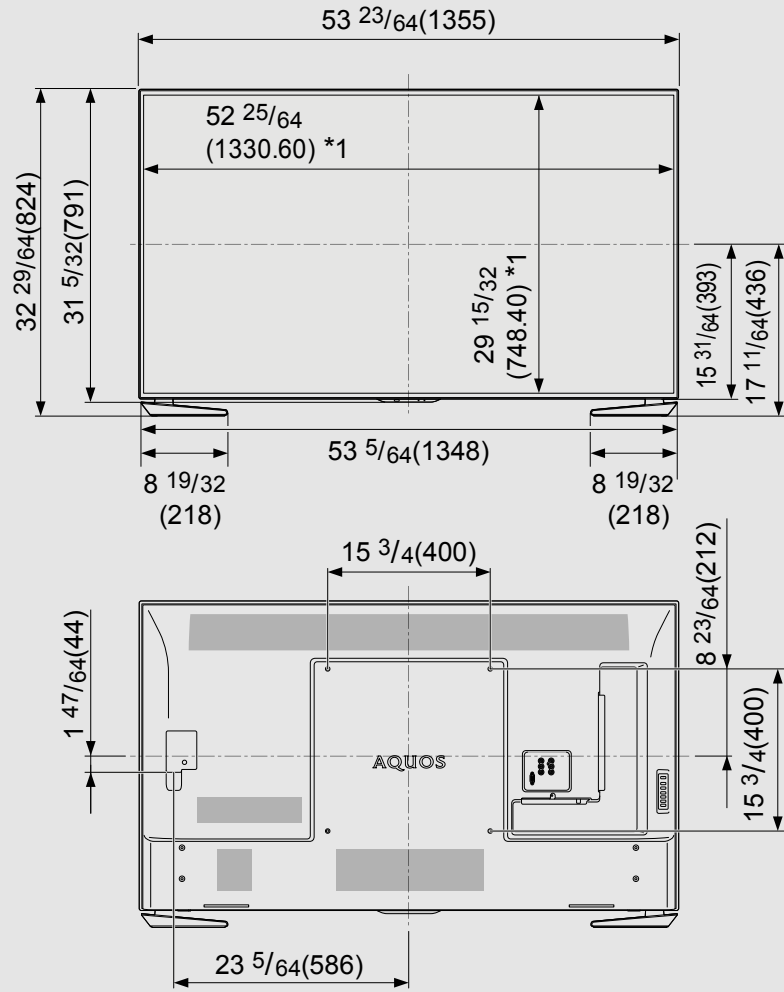

Unit: inch (mm)  
 Unite: pouce (mm)  
 Unidad: pulgada (mm)

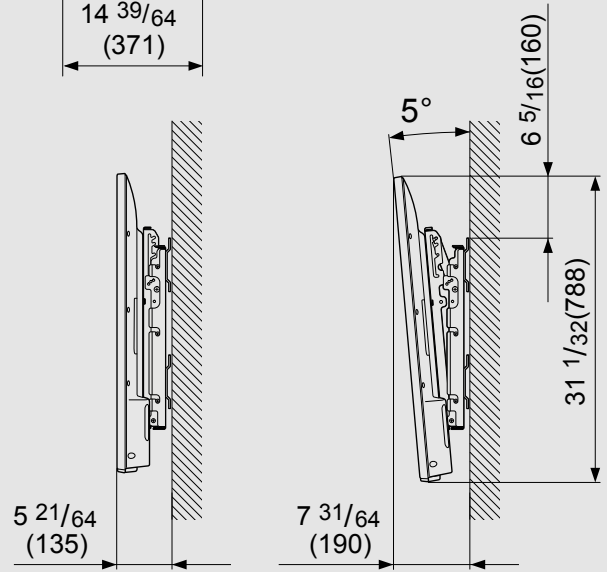

\*1 Active area/Area activa/Zone active  
 \*2 Thinnest part/Parte mas delgada/Partie la plus mince  
 \*3 Including projecting parts/Incluyendo partes salientes/Parties saillantes incluses



**SHARP®**

SHARP ELECTRONICS CORPORATION

1 Sharp Plaza, Suite 1, Mahwah, NJ 07495-1123

SHARP CORPORATION