

**OKI**<sup>®</sup>  
People to People Technology™



**MICROLINE 320/321 Turbo**

**9 Pin Printer**

# User's Guide



## **Document Title and Part Number**

Microline 320/321 Turbo User's Guide

P/N 59270107

## **Disclaimer**

Every effort has been made to ensure that the information in this document is complete, accurate, and up-to-date. Oki Data assumes no responsibility for the results of errors beyond its control. Oki Data also cannot guarantee that changes in software and equipment made by other manufacturers and referred to in this guide will not affect the applicability of the information in it. Mention of software products manufactured by other companies does not necessarily constitute endorsement by Oki Data.

## **Copyright Information**

Copyright 2001 by Oki Data. All rights reserved.

Revised edition March, 2001

Written and produced by the Oki Data Training and Publications Department.

## **Contact Information**

Please address any comments on this publication to:

### **Mailing Address**

Oki Data Americas, Inc.  
Training & Publications Dept.  
2000 Bishops Gate Blvd.  
Mt. Laurel, NJ 08054-4620

### **e-Mail Address**

pubs@okidata.com

### **Web Site**

Please visit Oki Data's multilingual web site at:

**<http://www.okidata.com>**

## **Trademark Information**

OKI, Oki Data and MICROLINE are registered trademarks of Oki Electric Industry Company, Ltd.

CompuServe is a registered trademark of CompuServ Inc.

Energy Star is a registered trademark of the United States Environmental Protection Agency

Epson is a registered trademark of Epson America, Inc.

IBM is a registered trademark of International Business Machines Corp.

Microsoft and Windows are either registered trademarks or trademarks of Microsoft Corporation in the United States and other countries.

# Contents

<b>Helpful Hints</b> .....	<b>7</b>	<b>Installation</b> .....	<b>19</b>
Saving Money .....	8	Installation Hints .....	19
Saving Money: Forms Tear-Off .....	8	Installation Overview .....	20
Saving Money: Draft Mode .....	8	Installation Location .....	20
Saving Time .....	9	Customizing the Installation .....	21
Saving Time: Internet Support .....	9	Unpacking the Machine .....	23
Saving Time: Draft Mode .....	9	Shipping Restraints .....	24
Saving Time: Paper Park .....	9	Ribbon Cartridge .....	25
Saving Time: Moving Through the Menu .....	9	Ribbon Cartridge Handling .....	26
Operation Tips .....	10	Ribbon Cartridge Emergency First Aid .....	26
Operation Tip: Top of Form .....	10	Computer Connections .....	27
Operation Tip: Turning the Platen Knob .....	11	Power Connections .....	28
Operation Tip: Control Access to the Printer .....	11	Paper Loading .....	29
<b>Introduction</b> .....	<b>12</b>	Emulations .....	33
Printer Features .....	13	Testing the Printer .....	34
<b>Parts Identification</b> .....	<b>14</b>	Font Sample Test .....	35
Printer Serial Number .....	14	Rolling ASCII Test .....	36
Parts Identification: Rear Feed (Continuous Forms) .....	15	Printer Drivers .....	37
Parts Identification: Top Feed (Single-Sheet) .....	16	Selecting Printer Drivers .....	37
Front Panel Lights .....	17	Obtaining Drivers .....	37
Front Panel Keys .....	18	Installing Printer Drivers .....	37

<b>Using Your Printer .....</b>	<b>38</b>
Top of Form (TOF) .....	38
Top of Form (TOF) and Forms Tear-Off .....	39
Forms Tear-Off Status (ON or OFF) .....	39
Setting Top of Form, Forms Tear-Off ON (Step A) .....	40
Setting Top of Form, Forms Tear-Off OFF (Step B) .....	42
Temporary Top of Form Change .....	44
Reset Top of Form to Factory Default .....	45
Printer ON .....	45
Printer OFF .....	45
Forms Tear-Off .....	46
Changing the Forms Tear-Off Setting .....	47
Automatic Forms Tear-Off .....	48
TEAR Key and Automatic Forms Tear-Off .....	48
Manual Forms Tear-Off .....	49
TEAR Key .....	50
Forms Tear-Off set OFF .....	50
Forms Tear-Off set ON .....	50
Paper Park .....	51
Changing Paper Paths .....	52
Continuous-forms to single-sheet feed .....	52
Single-sheet feed to continuous forms .....	52
Printhead Gap .....	53
Expanded Printhead Gap .....	54
Print Quality .....	58
Super Speed Draft .....	59

Printer Reset .....	59
Character Pitch .....	60
Menu Mode .....	61
Moving Through the Menu .....	62
Moving Forward .....	62
Moving Backward .....	62
Resetting Menu to Factory Defaults .....	63
Printing the Menu Settings .....	63
Changing the Menu Settings .....	64
Menu Settings Table .....	65
Explanations of Menu Items .....	70
<b>Maintenance .....</b>	<b>73</b>
Replacing the Ribbon Cartridge .....	73
Printer Cleaning .....	74
Paper Jams .....	75

<b>Troubleshooting .....</b>	<b>80</b>		
General Information .....	80		
Internet Support .....	80		
List of Problems .....	81		
Problem 1:			
My word processor files do not print the way I have the menu and front panel set. ....	82		
Problem 2:			
Nothing happens when I turn on the printer. ....	83		
Problem 3:			
The printer does not print when the computer sends data. ....	83		
Problem 4:			
I'm getting strange symbols, incorrect fonts, etc., when I try to print a document. ....	83		
Problem 5:			
Ink smears on the paper when I print on narrow forms. ...	84		
Problem 6:			
I've installed a new ribbon and the printing is smeared and streaked. ....	84		
Problem 7:			
The ALARM light is flashing. ....	84		
Problem 8:			
The ALARM light is on and the Character Pitch 10 light is flashing. ....	84		
		Problem 9:	
		The ALARM light is on and the Character Pitch 15 light is flashing. ....	85
		Problem 10:	
		The printer needs paper, but the ALARM light is not on and I cannot load the paper. ....	85
		Problem 11:	
		The Print Quality and Character Pitch keys on the front panel don't work. ....	85
		Problem 12:	
		Continuous-form paper sticks to the paper separator. ....	85
		<b>Specifications .....</b>	<b>86</b>
		<b>Service and Support .....</b>	<b>91</b>
		General Information .....	91
		Documentation .....	92
		Purchase Location .....	92
		Internet Support .....	93
		www.okidata.com .....	93
		my.okidata.com .....	93
		Telephone Support .....	94
		Service Centers .....	95
		Service and Support: United States and Canada .....	96
		Service and Support: Latin America .....	97

<b>Accessories .....</b>	<b>98</b>
Purchasing Accessories .....	98
Accessories: Part Numbers .....	99
Consumables: Part Numbers .....	99
Options: Part Numbers .....	99
Replacement Parts: Part Numbers .....	100
Documentation: Part Numbers .....	100
<b>Printer Control Codes .....</b>	<b>101</b>
Epson FX Commands .....	102
IBM Proprinter III Commands .....	104
Oki Data MICROLINE Standard Commands .....	106

<b>Warranty, Regulatory, and Safety Information</b>	<b>108</b>
Limited Warranty: United States and Canada .....	108
Limited Warranty: Latin America .....	110
Service and Support: United States and Canada .....	111
Sales and Service Dealers: United States and Canada ..	111
Telephone Support: United States and Canada .....	112
Service and Support: Latin America .....	113
Sales and Service Centers: Latin America .....	113
Customer Support Professionals: Latin America .....	113
Oki Data on the Internet .....	114
www.okidata.com .....	114
my.okidata.com .....	114
Oki Data Service Centers .....	115
Material Safety Data Sheet (MSDS) .....	116
Emergency Information: MSDS .....	116
Safety Information .....	120
Regulatory Information .....	121
Year 2000 Compliance .....	121
Energy Star® .....	121
Federal Communications Commission (FCC) .....	122
Industry Canada (IC) .....	123
European Union Council of the European Communities	124
<b>Index .....</b>	<b>125</b>

# Helpful Hints

Your printer has many features and capabilities that will help you

- save money
- save time
- operate the machine

This section summarizes the features and capabilities directly connected to saving money and time.

Details for these features and capabilities are provided in other sections of this document.

You may want to use some of our Helpful Hints when working with your machine.

## Saving Money

### Saving Money: Forms Tear-Off

The Forms Tear-Off feature allows a printed page (rear feed, continuous form) to be torn off without wasting paper or adjusting the printer.

Forms Tear-Off automatically moves the paper from the initial printing position (print start position) to the tear-off position, after a time interval (which you select through the menu).

The top of the page (perforation) is even with the tear bar. The tear bar is located under the clear top of the access cover.

Paper remains in the tear-off position until the printer receives more data. Then, the paper moves back down for printing (retracts to the initial print position).

When printing stops, the paper will advance to the tear-off position.

This feature is normally turned off.

Forms Tear-Off and the Top of Form settings interact.

For more information, refer to “Using Your Printer, Forms Tear-Off and Using Your Printer, Top of Form.”

### Saving Money: Draft Mode

When printing drafts of documents, use either the High Speed Draft or Super Speed Draft mode. These modes use less ink than the Utility or Near Letter Quality Modes, thus extending the life of your ribbon. The draft modes also print at high speeds, reducing the time required to complete a print job.

For more information, refer to “Using Your Printer, Print Quality.”



## **Saving Time**

### **Saving Time: Internet Support**

Oki Data provides support via the Internet.

Oki Data's main web site, [www.okidata.com](http://www.okidata.com), is the gateway to Oki Data's products and services.

[my.okidata.com](http://my.okidata.com) is a powerful area of Oki Data's web site designed to help you personalize the information and service you get from Oki Data.

You can find information at your convenience, at any time.

For more information, refer to "Service and Support, Internet Support."

### **Saving Time: Draft Mode**

When printing drafts of documents, use either the High Speed Draft or Super Speed Draft mode. The draft modes print at high speeds, reducing the time required to complete a print job. These modes also use less ink than the Utility or Near Letter Quality Modes, thus extending the life of your ribbon.

For more information, refer to "Using Your Printer, Print Quality."

### **Saving Time: Paper Park**

Your printer's paper park feature allows you to print a single sheet (cut-sheet) page without removing continuous feed paper from the printer.

For more information, refer to "Using Your Printer, Paper Park."

### **Saving Time: Moving Through the Menu**

When the printer is in Menu Mode, you can move forward or backwards through the menu.

To move forward, press GROUP, ITEM, or Set, whichever is appropriate.

To move backward, press and hold SHIFT, then GROUP, ITEM, or Set, whichever is appropriate.

For more information, refer to "Using Your Printer, Menu Mode."

## Operation Tips

### Operation Tip: Top of Form

- ! *If you turn the platen knob when the printer is turned on, you will cause the Top of Form to mis-align. Always turn the printer off before turning the platen knob!*
- ! *Always determine the status of the Forms Tear-Off menu setting BEFORE setting the Top of Form. Refer to “Using Your Printer, Top of Form, Forms Tear-Off Status (ON or OFF).”*

Top of Form sets the print start position for the printer. It is adjustable in increments of 1/144 of an inch. The amount of adjustment is limited to avoid paper jams.

The Top of Form may be left at the factory default (1 inch), changed for a single print job, or set to a new (permanent) default.

The first line prints at the red line of the plastic paper shield (1) on the printhead.

The Top of Form and Forms Tear-Off settings of your printer interact.

How you set the Top of Form depends on the status of the Forms Tear-Off menu setting.

For more information, refer to “Using Your Printer, Top of Form (TOF).”

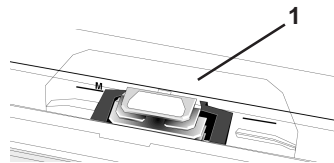

## Operation Tip: Turning the Platen Knob

- ! *If you turn the platen knob when the printer is turned on, you will cause the Top of Form to mis-align. Always turn the printer off before turning the platen knob!*

## Operation Tip: Control Access to the Printer

You can control access to the printer by changing the setting for the Operator Panel Function (in the Menu).

When the Operator Panel Function is set to Full Operation (the factory default), all keys on the front panel operate.

When the Operator Panel Function is set to Limited Operation, the PRINT QUALITY and CHARACTER PITCH keys don't work. This prevents these settings from being changed from the control panel when several people are using the printer.

For more information, refer to “Using Your Printer, Menu Mode, Menu Settings Table, Setup, Operator Panel Function.”

# Introduction

Thank you for purchasing this printer.

This rugged 9-pin printer can meet the needs of harsh and demanding environments. The expanded printhead gap, zero-tear capability, and multiple paper feed paths allow the printer to handle a wide variety of media, including 6-part forms. Your printer will provide years of dependable and efficient service.

In addition to the many standard features, options can expand the machine's capabilities.

For information on the options, see "Accessories."

## Oki Data on the Internet

The Oki Data Web Sites provide the most current information available on your product.

An on-line version of this document is available for viewing and downloading via Oki Data's Web Sites.

You may reach Oki Data via the Internet at:

- [www.okidata.com](http://www.okidata.com)
- [www.my.okidata.com](http://www.my.okidata.com)

For more information on the Oki Data Web Sites, refer to "Service and Support, Internet Support."

## Printer Features

- Super reliable, durable operation: 10,000 hours Mean Time Between Failures (MTBF)!
- Expandable head gap for handling forms up to 0.031" (0.79 mm) thick through the bottom feed path using the optional push and/or pull tractor.
- Advanced paper handling, with built-in rear push tractor and zero-tear forms capability.
- Blazing print speeds:
  - 300 characters per second (cps) in Utility mode
  - 390 cps in High Speed Draft (HSD) mode
  - 435 cps in Super Speed Draft (SSD) mode
- 100% backward compatible with Microline 320/321 printers.

# Parts Identification

The parts identified here are parts of the unit that you will use during normal operation.

For accessories (consumables, options, replacement parts, and documentation), refer to “Accessories.”

## Printer Serial Number

The serial number of your machine is on a label on the back of your machine.

The label says “S/N.”

An example serial number is: 401A0154693.

- ! ***You will need your printer serial number if your machine requires servicing.***
- ***A written receipt for the product, showing the date of purchase, dealer’s name, and both the model and serial numbers of the product must accompany any request or claim for work to be performed under Limited Warranty.***

## Parts Identification: Rear Feed (Continuous Forms)

- 1 Paper Guides
- 2 Paper Separator
- 3 Paper Lever
- 4 On-Off Switch
- 5 Platen Knob
- 6 Control Panel
- 7 Acoustic Cover
- 8 Access Cover

- ! *Move the paper lever to the position marked “REAR.”*
- *For rear feed, the paper lever is towards the front of the printer.*

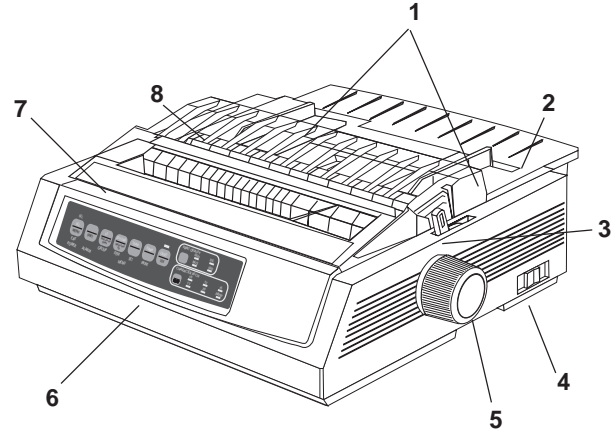

## Parts Identification: Top Feed (Single-Sheet)

- 1 Paper Guides
- 2 Paper Separator
- 3 Paper Lever
- 4 On-Off Switch
- 5 Platen Knob
- 6 Control Panel
- 7 Acoustic Cover (open)
- 8 Access Cover

- ! *Move the paper lever to the position marked “TOP.”*
- *The paper lever is towards the back of the printer.*

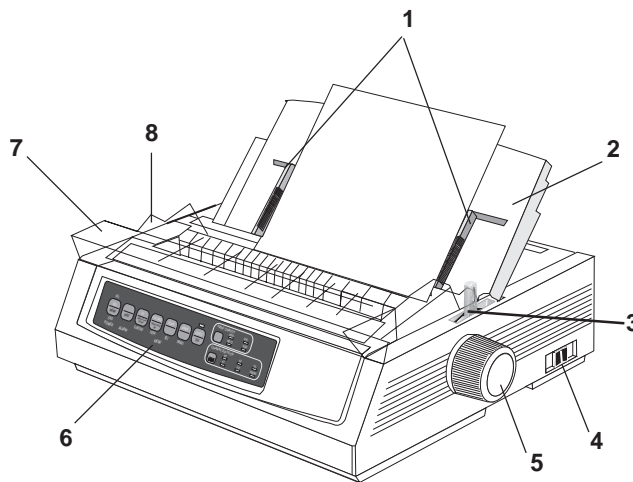



# Front Panel Lights

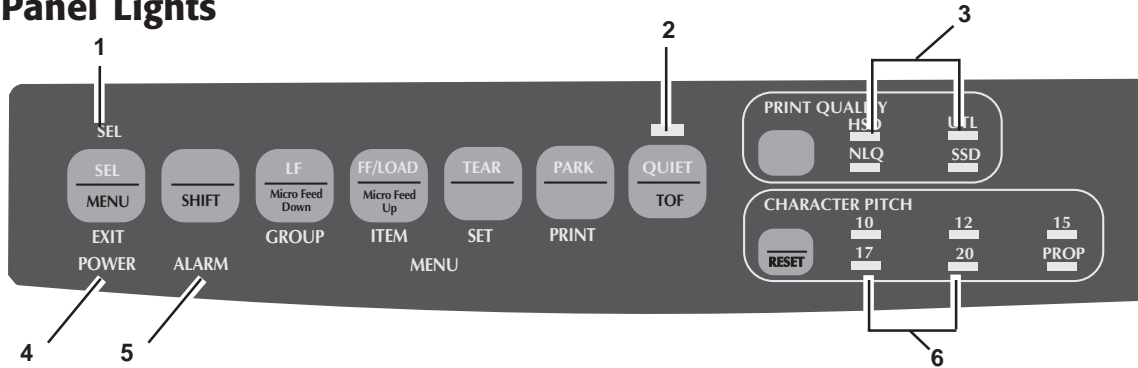

- 1 SEL:** Glows = printer selected, ready to receive data  
Flashes = printer in Print Suppress Mode  
Not lit = printer deselected (cannot receive data)
- 2 QUIET:** Glows = printer is in Quiet state.
- 3 HSD / UTL / NLQ / SSD:** Indicate print quality selected.
- 4 POWER:** Glows = printer is turned on.
- 5 ALARM:** Glows = error condition exists:
  - out of paper (no other lights blinking)
  - paper jam if 15 cpi light is also blinking
  - paper lever is set to wrong position if 10 cpi light is also blinking.
  - Blinks = error condition. Turn printer off, then on; if light still flashes, contact service dealer.
- 6 10 / 12 / 15 / 17 / 20 / PROP:**  
Indicate selected character pitch.

## Front Panel Keys

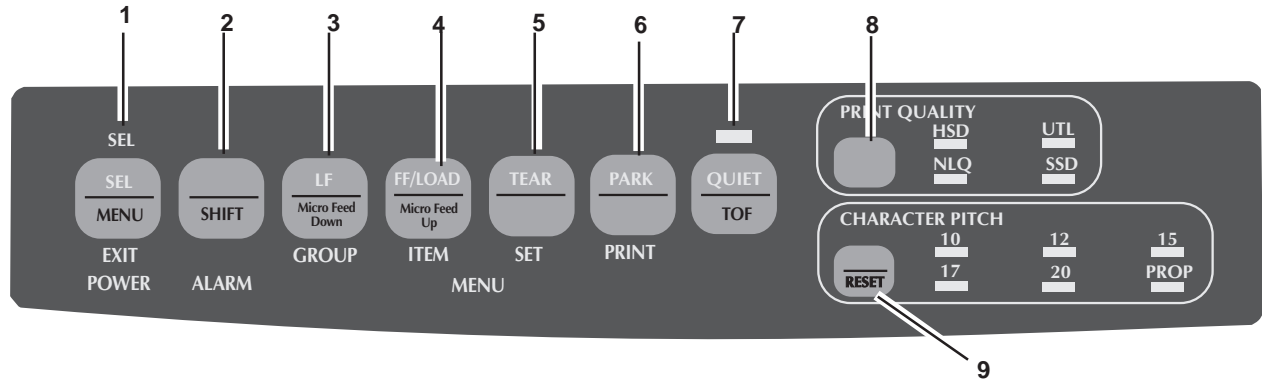

- 1 SEL:** Selects/deselects printer (printer on-line / off-line). When held on power up, or with SHIFT key, engages Menu Mode.
- 2 SHIFT:** Press and hold while pressing another key to engage the alternate function for that key (e.g., “Micro Feed Down” for LF key).
- 3 LF:** Moves paper up one line: press and hold for repetitive line feeds. When held on power up, activates Font Test.
- 4 FF/LOAD:** Loads/ejects single sheet of paper; loads continuous-form paper or feeds it to next page.
- 5 TEAR:** Moves continuous-form paper up for tear-off or back down for printing.
- 6 PARK:** Retracts continuous-form paper from the path.
- 7 QUIET:** Turns Quiet Mode on and off. When held on power up, activates Rolling ASCII Test.
- 8 PRINT QUALITY:** Selects print quality and font.
- 9 CHARACTER PITCH:** Selects the character pitch. Used with SHIFT key to reset the printer and clear the buffer.

# Installation

## Installation Hints

- Read the setup and operating instructions in this document carefully. Be sure to save this document for future reference.
- Read and follow all warning and instruction labels on the printer itself.
- Place your printer on a firm, solid surface. If you put it on something unsteady, it might fall and be damaged. If you place it on a soft surface (such as a rug, sofa, or bed) the vents may be blocked, causing it to overheat.
- The printer must be installed near a power outlet which will remain easily accessible.
- Be certain that your power source matches the rating listed on the back of the printer. If you are not sure, check with your dealer or with your local power company.
- Your printer has a grounded, 3-prong plug as a safety feature, and it will only fit into a grounded outlet. If you can not plug it in, chances are that you have an older, non-grounded outlet. Contact an electrician to have it replaced with a grounded outlet. Do not use an adapter to defeat the grounding.
- To avoid damaging the power cord, do not put anything on it or place it where it will be walked on. If the cord becomes damaged or frayed, replace it immediately.

- If you're using an extension cord or power strip with the printer, make sure that the total of the amperes required by all the equipment on the extension is less than the extension's rating. Generally, the total ratings of all equipment plugged into any one power line should not exceed 15 amperes. Don't exceed this unless you know that the power line your equipment is plugged into has a rating above 15 amperes.
- To protect your printer from overheating, make sure no openings on the printer are blocked. Do not put the printer on or near a heat source, such as a radiator or heat register. If you put the printer in any kind of enclosure, make sure it is well ventilated.

## Installation Overview

To install your new printer, follow the instructions from the “Installation, Installation Location” to “Installation, Printer Drivers” sections of this document. You must complete these steps for your printer to operate properly.

If you have purchased an option package for your printer, refer to the documentation you received with that option for installation instructions.

## Installation Location

- Place your printer on a firm, solid surface.
- Allow enough space on each side of the machine to easily access the platen knob and the various paper feed paths.
- Make sure a power outlet is available nearby.

## Customizing the Installation

Your printer has many settings (defaults) that do not need to be adjusted as part of a standard installation.

However, you may need to adjust settings to fit your standards.

Some settings you may need to adjust as part of your installation are:

- Top of Form (TOF)
- Paper Path
- Printhead Gap

To adjust these settings, refer to the appropriate section in “Using Your Printer.”

## Top of Form (TOF)

- ! *If you turn the platen knob when the printer is turned on, you will cause the Top of Form to mis-align. Always turn the printer off before turning the platen knob!*
- ! *The factory default setting for the Top of Form (where the printing should begin) is one inch down from the top of the page.*
- ! *Your software may print the first line of print above or below where TOF is set. You may need to adjust the TOF to meet your software's needs. Use the procedures in "Using Your Printer, Top of Form, Forms Tear-Off Status (ON or OFF)."*
- ! *The first line prints at the red line of the plastic paper shield (1) on the printhead.*

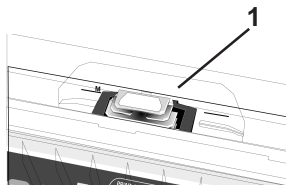

The Top of Form and Forms Tear-Off settings of your printer interact.

How you set the Top of Form depends on the status of the Forms Tear-Off menu setting.

If Forms Tear-Off is activated (set to ON), set the Top of Form using "Using Your Printer, Setting Top of Form, Forms Tear-Off ON (Step A)."

If Forms Tear-Off is NOT activated (set to OFF), set the Top of Form using the "Using Your Printer, Setting Top of Form, Forms Tear-Off OFF (Step B)."

# Unpacking the Machine

Before you begin, be sure that all the items listed below are included in your package.

- ! *If any items are missing, contact your dealer*
- *immediately. Keep you packing materials and carton in case you ever need to ship or transport the unit.*

- 1 Printer
- 2 Ribbon Cartridge
- 3 Power Cord

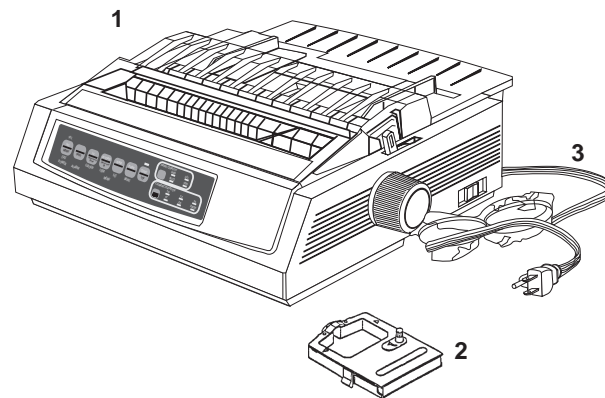

# Shipping Restraints

1 Open the access cover (1). Remove the printhead shipping restraint (2) and tape.

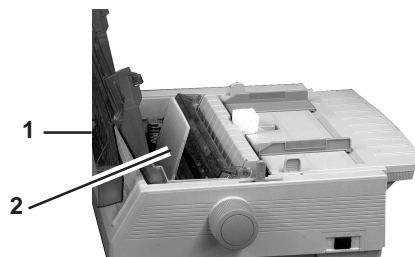

2 Grasp the tabs and lift off the paper separator (1). Remove the shipping restraint (2).

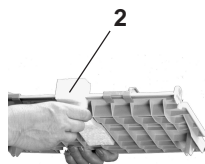
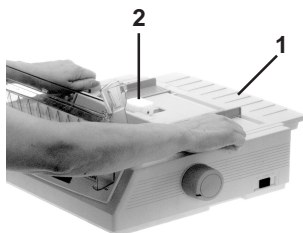

3 Install the paper separator.



! *Keep your packing materials and carton in case you ever need to ship or transport the unit.*



# Ribbon Cartridge

1 *Make sure the printer is turned OFF.*

2 Center the printhead (1).

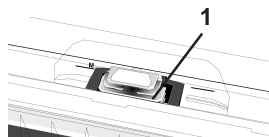

3 *If you are replacing the ribbon:* swing the front of the cartridge up off the printhead, then lift the cartridge out and discard it.

! **Caution!** *The printhead may be HOT!*

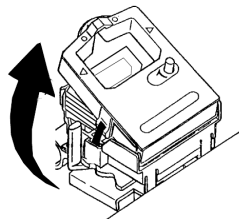

4 Unpack the ribbon cartridge.

! **Important!** *DO NOT remove the ribbon shield from the ribbon!*

1 Ribbon Shield

2 Grip Points

3 Take-up Knob

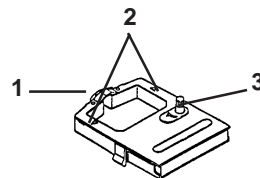

5 Install the new ribbon cartridge.

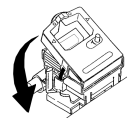

6 Turn the take-up knob in the direction of the arrow to take up any ribbon slack.

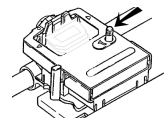

## Ribbon Cartridge Handling

- Leave unused ribbon cartridges in their packages until needed.
- When replacing a ribbon cartridge, re-use the packaging to dispose of the old ribbon cartridge.
- Be careful when removing the ribbon cartridge. Do not let it touch your clothing or porous materials. The ribbon ink may cause permanent stains.
- Ribbon ink on skin or clothing can usually be removed with soap and water.

## Ribbon Cartridge Emergency First Aid

### **Contact occurs with eyes.**

Flush eyes with large quantities of water for 15 minutes, keeping eyelids open with fingers. Seek medical attention.

### **Contact occurs with skin**

Wash thoroughly with soap and water.

### **For more information**

Refer to the Material Safety Data Sheet in “Warranty, Regulatory, and Safety Information.”

# Computer Connections

Three interface types are available for your printer.

- Parallel
- Serial (25 pin)
- Network (RJ45)

Attach the interface cable to the appropriate port on your computer.

- ! ***FCC regulations require the use of a shielded cable no longer than 6 ft. (1.8 m).***

***An IEE 1284-compatible parallel cable is needed for bi-directional communications.***

***If you purchased the Serial Interface option, see the instruction sheet provided with it.***

- 1 Plug the interface cable into the parallel port (1) and secure it with the wire loops.

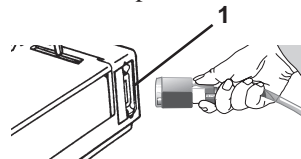

- 2 Attach the other end of the cable to your computer.

## Power Connections

- 1 *Make sure both the printer and the computer are OFF.*
- 2 Plug the power cord into the back of the printer (1), then into a grounded outlet (2).

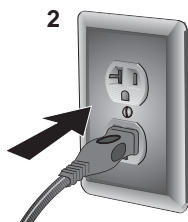
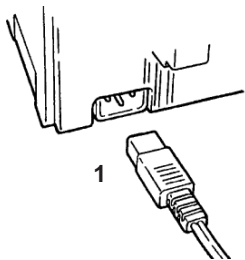

- 3 Turn on the printer.

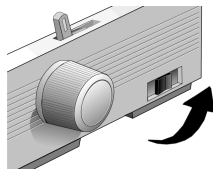

# Paper Loading

## Rear Feed, Continuous Forms

Use the rear-feed path for printing on single-thickness, continuous-form paper.

Use the single-sheet path (top feed) for graphics or charts.

**!** *If you have paper in the paper path, be sure to remove it before installing rear-feed paper.*

- 1 Lock Lever
- 2 Upper Tractor Cover
- 3 Pins
- 4 Lower Tractor Cover

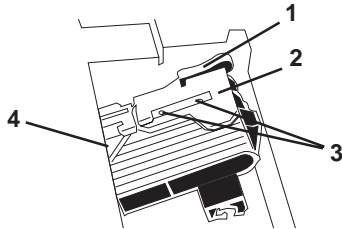

- 1 Move the paper lever to the position marked “REAR.”

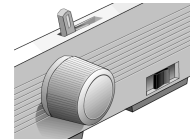

- 2 Grasp the tabs lift off the paper separator.

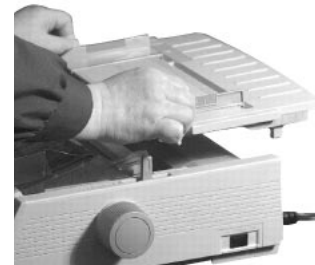

- 3** Pull up on the lock levers and open the tractor covers. Then, move the right tractor to fit the width of the paper.

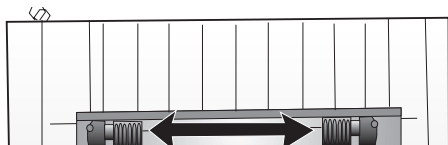

- 4** Place the first two holes in the paper over the tractor pins on either side. Close the tractor covers.



- 5** Move the left tractor to align the edge of the paper with the appropriate reference mark (1). Then, push back the lock lever.

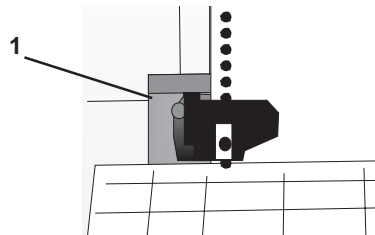

- 6** Adjust the position of the right tractor to center the holes in the paper on the pins. Then, push back the right lock lever.



- 7 Install the paper separator. Place the wire guide (1) on the pull-up roller assembly (2).

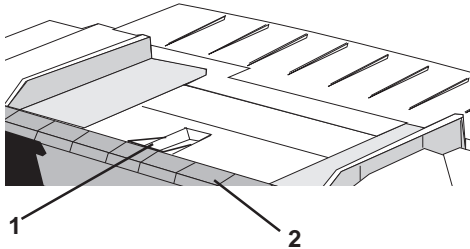

- 8 Press FF/LOAD. The paper feeds into the printer.
- ! ***The factory default setting for the Top of Form (where the printing should begin) is one inch down from the top of the page. To change the setting, see “Using Your Printer, Top of Form (TOF).”***

## Top Feed (Single Sheets)

Use the single-sheet path for letterhead stationery, memos, and individual envelopes.

- ! ***If you have continuous-form paper in the path, press PARK to remove it before loading single sheets.***

- 1 Make sure the printer is on and deselected (SEL light off).
- 2 Place the paper lever in the position marked “TOP.”

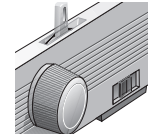

- 3 Open the carriage cover. Raise the paper separator to the single-sheet position.

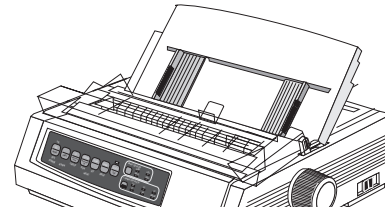

- 4 Make sure the wire feed guide (1) is secured in the sheet guide.

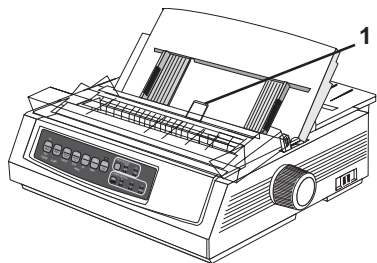

- 5 Adjust the paper feed guides (1) for the width of the paper. Place a sheet of paper in the separator. The paper will feed into the printer.

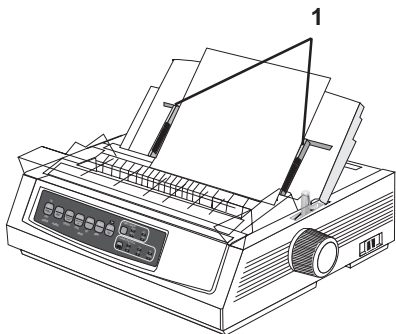

- ! **Important!**
- *If the paper does not feed in, remove it. Check the paper lever position. Make sure the ALARM light is on: if it is flashing, hold the SHIFT key and press the CHARACTER PITCH (RESET) key. Reload the sheet of paper.*
  - ! *The factory default setting for the Top of Form (where the printing should begin) is one inch down from the top of the page. To change the setting, see “Using Your Printer, Top of Form (TOF).”*



# Emulations

## Available Emulations

Your printer has three emulations:

- Epson® FX (ESC/P)
- IBM® Proprinter III (PPSII) — *factory setting*
- OKIDATA® MICROLINE® Standard

## Changing Emulations

- 1 Make sure paper is loaded.
- 2 Press SHIFT + SEL. The printer enters the Menu Mode.
- 3 Press LF. The following line prints:  
Printer Control Emulation Mode IBM PPR
- 4 Press TEAR consecutively until the emulation you wish to select prints in the right-hand column.
- 5 Press SHIFT + SEL to save your setting and exit the Menu Mode.

## Testing the Printer

Running the printer self tests is a good way to check the installation of your printer.

The two self tests are:

- Font Sample Test
- Rolling ASCII Test

- ! ***Microline 321 Turbo (wide carriage model)***
- ***If you are using 8.5 inch paper to run the test, make sure the paper width selection in the printer menu is set to 8.5 inches. Otherwise, printing on the platen may damage the printer. Refer to “Using Your Printer, Menu Mode, Explanations of Menu Items.”***

## Font Sample Test

- ! ***Microline 321 Turbo (wide carriage model)***
- ***If you are using 8.5 inch paper to run the test, make sure the paper width selection in the printer menu is set to 8.5 inches. Otherwise, printing on the platen may damage the printer. Refer to “Using Your Printer, Menu Mode, Explanations of Menu Items.”***

The Font Sample Test prints a sample of the fonts standard to the printer.

The top of the printout has the Printer Model, Emulation, Country Code, Interface, and Firmware Revision Level for your printer.

To run the test:

- Turn the printer off, then press and hold the LF key while turning the printer back on.



To exit the test:

- Press SEL.



## Rolling ASCII Test

- 📌 **Microline 321 Turbo (wide carriage model)**
- ***If you are using 8.5 inch paper to run the test, make sure the paper width selection in the printer menu is set to 8.5 inches. Otherwise, printing on the platen may damage the printer. Refer to “Using Your Printer, Menu Mode, Explanations of Menu Items.”***

The Rolling ASCII Print Test produces a continuous printout of all 96 ASCII characters in a rolling pattern. The type style set in the printer menu will be utilized.

Use the Rolling ASCII Test to check the following.

- Print Quality
  - Across the entire length of a line
  - Down the entire page
- Line Spacing
- Character Formation

The top of the printout has the Printer Model, Emulation, Country Code, and Firmware Revision Level.

To run the test:

- Turn the printer off, then press and hold the QUIET key while turning the printer back on.



To exit the test:

- Press SEL.



# Printer Drivers

## Selecting Printer Drivers

Before you can use your printer, you must select the correct printer driver in your software. If you select the wrong driver, you will see strange characters, incorrect fonts, etc.

- ! *See your software documentation for information on*
- *how to select a printer driver.*

The drivers below are listed by **decreasing** compatibility with your printer. *Use one as close to the top of the list as possible.*

### **Epson FX**

Oki Data ML320/1T Epson  
Oki Data ML320/1 Epson  
Epson FX286e  
Epson FX 850/1050  
Epson FX 800/1000  
Epson FX

### **IBM Proprinter III**

Oki Data ML320/1T IBM  
Oki Data ML320/1 IBM  
IBM Proprinter III  
IBM Proprinter II  
IBM Proprinter  
IBM Graphics Printer

### **Oki Data Microline Standard**

Oki Data Microline 320/321T  
Oki Data Microline 320/321  
Oki Data Microline 520/521  
Oki Data Microline 292/293  
Oki Data Microline 192/193

## Obtaining Drivers

Drivers are available for a variety of operating systems.

You can obtain the drivers by downloading them from the web site at

<http://www.okidata.com>

## Installing Printer Drivers

Installation procedures vary according to the driver you select. Follow the instructions provided with the selected driver.

# Using Your Printer

## Top of Form (TOF)

- ! *If you turn the platen knob when the printer is turned on, you will cause the Top of Form to mis-align. Always turn the printer off before turning the platen knob!*
- ! *The factory default setting for the Top of Form (where the printing should begin) is one inch down from the top of the page.*
- ! *Your software may print the first line of print above or below where TOF is set. You may need to adjust the TOF to meet your software's needs. Use the procedures in "Using Your Printer, Top of Form, Forms Tear-Off Status (ON or OFF)."*

Top of Form sets the print start position for the printer. It is adjustable in increments of 1/144 of an inch. The amount of adjustment is limited to avoid paper jams.

The first line prints at the red line of the plastic paper shield (1) on the printhead.

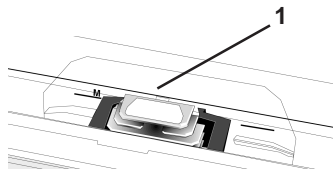

## Top of Form (TOF) and Forms Tear-Off

- ! *If you turn the platen knob when the printer is turned on, you will cause the Top of Form to mis-align. Always turn the printer off before turning the platen knob!*
- ! *Your software may print the first line of print above or below where TOF is set. You may need to adjust the TOF to meet your software's needs. Use the procedures in "Using Your Printer, Top of Form, Forms Tear-Off Status (ON or OFF)."*

The Top of Form and Forms Tear-Off settings of your printer interact.

How you set the Top of Form depends on the status of the Forms Tear-Off menu setting.

If Forms Tear-Off is activated (set to ON), set the Top of Form using Step A.

Refer to "Using Your Printer, Setting Top of Form, Forms Tear-Off ON (Step A)."

If Forms Tear-Off is NOT activated (set to OFF), set the Top of Form using Step B.

Refer to "Using Your Printer, Setting Top of Form, Forms Tear-Off OFF (Step B)."

## Forms Tear-Off Status (ON or OFF)

Before you set the Top of Form, you need to know the status of the Forms Tear-Off menu setting (whether it is ON or OFF). There are two ways to determine the status of the Forms Tear-Off menu setting.

- print the Menu.
- use the TEAR key

To print the Menu, refer to "Using Your Printer, Menu Mode, Print the Menu Settings."

To use the TEAR key:

- 1 Load paper.
- 2 Press TEAR.
- 3 If the paper moves up, then Forms Tear-off is OFF.  
If the paper moves down, then Forms Tear-off is ON.

## Setting Top of Form, Forms Tear-Off ON (Step A)

- ! *If you turn the platen knob when the printer is turned on, you will cause the Top of Form to mis-align. Always turn the printer off before turning the platen knob!*
- ! *Always determine the status of the Forms Tear-Off menu setting BEFORE setting the Top of Form. Refer to “Using Your Printer, Top of Form, Forms Tear-Off Status (ON or OFF).”*

- 1 Turn the printer ON.
- 2 Park the paper.
- 3 With paper out of the unit, (red alarm light should be on) press SHIFT (1) and QUIET/TOF (5) to reset the current Top of Form.
- 4 Press FF/LOAD (3) to load the paper.
- 5 Press SEL/MENU (6) to take the printer off line.  
The SEL light goes out.
- 6 Wait until the paper moves up to the tear position, then press and hold TEAR (4).  
The paper moves to the current Top of Form.  
Keep pressing and holding TEAR.
- 7 Press and hold SHIFT and release TEAR.



8 As you continue to hold SHIFT, press the LF / Micro Feed Down (2), or FF/LOAD / Micro Feed Up (3), depending on which direction you want to move the paper to align Top of Form.

Press LF / Micro Feed Down to decrease the space (move Top of Form higher). The paper moves down.

Press FF/LOAD / Micro Feed Up to increase the space (move Top of Form lower). The paper moves up.

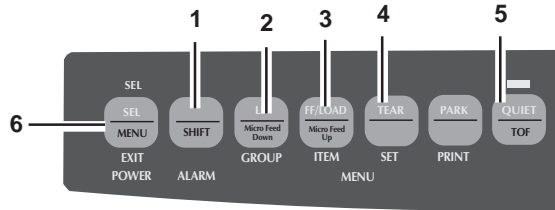

! The first line prints at the red line of the plastic paper shield (7) on the printhead.

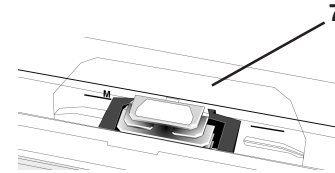

9 Keep holding SHIFT and press QUIET/TOF a few times to set the Top of Form.

10 When the Top of Form is at the correct position, release all keys.

11 Press SEL/MENU to place the printer on-line.

## Setting Top of Form, Forms Tear-Off OFF (Step B)

- ! *If you turn the platen knob when the printer is turned on, you will cause the Top of Form to mis-align. Always turn the printer off before turning the platen knob!*
- ! *Always determine the status of the Forms Tear-Off menu setting BEFORE setting the Top of Form. Refer to “Using Your Printer, Top of Form, Forms Tear-Off Status (ON or OFF).”*

- 1 Turn the printer ON.
- 2 Press SEL/MENU (6) to take the printer off line. The SEL light goes out.
- 3 Press and hold SHIFT (1).  
Then, press LF / Micro Feed Down (2) or FF/LOAD / Micro Feed Up (3), depending on which direction you want to move the paper to align the tear-off position.

Press LF / Micro Feed Down to decrease the space (move Top of Form higher). The paper moves down.

Press FF/LOAD / Micro Feed Up to increase the space (move Top of Form lower). The paper moves up.

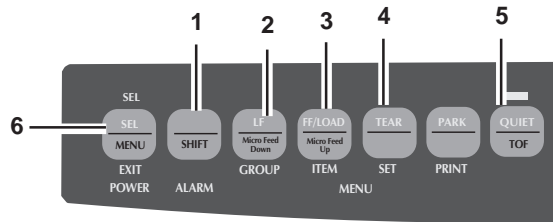

- ! **The first line prints at the red line of the plastic paper shield (7) on the printhead.**

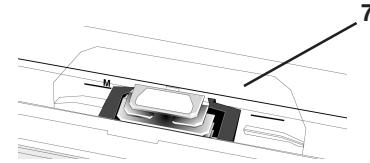

- 4 Keep holding SHIFT and press QUIET/TOF a few times to set the Top of Form.
- 5 When Top of Form is at the correct position, release all keys.
- 6 Press SEL/MENU to place the printer on line.

- ! **If you turn the platen knob when the printer is turned on, you will cause the Top of Form to mis-align. Always turn the printer off before turning the platen knob!**

- ! **For information on resetting the Top of Form to the factory default, refer to “Using Your Printer, Top of Form, Reset Top of Form to Factory Default.”**

## Temporary Top of Form Change

- ! *If you turn the platen knob when the printer is turned on, you will cause the Top of Form to mis-align. Always turn the printer off before turning the platen knob!*
- ! *The factory default setting for the Top of Form (where the printing should begin) is one inch down from the top of the page.*

To change the Top of Form (move it lower) *for one page only*:

- 1 Press SEL to deselect the printer.
- 2 Press LF to change the position of the Top of Form.

## Reset Top of Form to Factory Default

- ! *If you turn the platen knob when the printer is turned on, you will cause the Top of Form to mis-align. Always turn the printer off before turning the platen knob!*
- ! *The factory default setting for the Top of Form (where the printing should begin) is one inch down from the top of the page.*

There are two ways to reset the Top of Form to the factory default.

- with the printer ON.
- with the printer OFF.

### Printer ON

- 1 With the printer ON, and paper parked (out of the printer) Press QUIET / TOF.

### Printer OFF

- 1 With the printer OFF, and no paper installed, Press and hold PARK + QUIET/TOF while turning on the printer.

## Forms Tear-Off

- ! *The status of the Forms Tear-Off menu setting affects how you set the Top of Form.*

*To determine the status of the Forms Tear-Off menu setting, refer to “Using Your Printer, Top of Form, Forms Tear-Off Status (ON or OFF).”*

*For information on setting the Top of Form, refer to “Using Your Printer, Top of Form, Setting Top of Form, Forms Tear-Off (ON or OFF).”*

The Forms Tear-Off feature allows a printed page (continuous forms, rear or bottom feed, with no pull tractor option installed) to be torn off without wasting paper or adjusting the printer.

Forms Tear Off automatically moves the paper from the initial printing position to the tear-off position, after a time interval (which you select through the menu).

The top of the page (perforation) is even with the tear bar. The tear bar is located under the clear top of the access cover.

Paper remains in the tear-off position until the printer receives more data. Then, the paper moves back down for printing (retracts to the initial print position).

When printing stops, the paper advances to the tear-off position.

The default setting for Forms Tear-Off is OFF.

There are two types of Forms Tear-Off.

- Automatic Forms Tear-Off
- Manual Forms Tear-Off

- ! *If the software package you are using “pauses” while sending data to the printer, Forms Tear-Off may be activated (if it is enabled through the Menu). The pause must be for two or more seconds. No data is lost. Uneven print registration will occur due to the paper movement. If the problem occurs, use the menu to turn off this feature.*

- ! *DO NOT use Forms Tear-Off with labels or multi-part forms!*

- ! *Forms Tear-Off CANNOT be used when the optional pull tractor is engaged.*

## Changing the Forms Tear-Off Setting

The default setting for Forms Tear-Off is OFF.

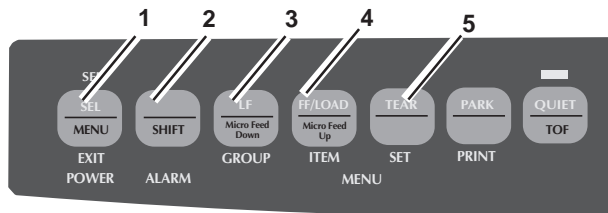

To change the Forms Tear-Off setting:

- 1 Press SEL (1) + SHIFT (2).
- 2 Press GROUP (3) until one of the following lines appears, depending on which paper feed you are using  
REAR FEED                      Form Tear-Off    OFF  
BOTTOM FEED                    Form Tear-Off    OFF
- 3 Press ITEM (4) until Form Tear-Off appears in the second column.
- 4 Press SET (5) until the time interval you wish to select appears in the third column.
- 5 Press SEL (1) + SHIFT (2) to exit Menu Mode and save the setting.

- ! *The status of the Forms Tear-Off menu setting affects how you set the Top of Form.*
- ! *If the software package you are using “pauses” while sending data to the printer, Forms Tear-Off may be activated (if it is enabled through the Menu). The pause must be for two seconds or more. No data is lost. Uneven print registration will occur due to the paper movement. If the problem occurs, use the menu to turn off Forms Tear-Off.*
- ! *DO NOT use Forms Tear-Off with labels or multi-part forms!*
- ! *Forms Tear-Off CANNOT be used when the optional pull tractor is engaged.*

## Automatic Forms Tear-Off

Forms Tear-Off must be set to ON in the menu for Automatic Forms Tear-Off to occur.

Automatic Forms Tear-Off automatically moves the paper from the initial printing position (print start position) to the tear-off position, after a time interval which you select through the menu.

The top of the page (perforation) is even with the tear bar. The tear bar is located under the clear top of the access cover.

Paper remains in the tear-off position until the printer receives more data. Then, the paper moves back down for printing (retracts to the initial print position).

When printing stops, the paper advances to the tear-off position.

### TEAR Key and Automatic Forms Tear-Off

If you press TEAR (1) when Forms Tear-Off is turned on (activated in the printer menu), the printer retracts the paper to the Top of Form position.

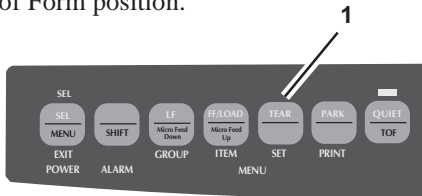

- ! *The status of the Forms Tear-Off menu setting affects how you set the Top of Form.*

*To determine the status of the Forms Tear-Off menu setting, refer to “Using Your Printer, Top of Form, Forms Tear-Off Status (ON or OFF).”*

*For information on setting the Top of Form, refer to “Using Your Printer, Top of Form, Setting Top of Form, Forms Tear-Off (ON or OFF).”*

- ! *If the software package you are using “pauses” while sending data to the printer, Forms Tear Off may be activated (if it is enabled through the Menu). The pause must be for two or more seconds. No data is lost. Uneven print registration will occur due to the paper movement. If the problem occurs, use the menu to turn off this feature.*

- ! *DO NOT use Forms Tear Off with labels or multi-part forms!*

- ! *Forms Tear-Off CANNOT be used when the optional pull tractor is engaged.*



## Manual Forms Tear-Off

Manual Forms Tear-Off allows you to advance a single page to the tear-off position.

Manual Forms Tear-Off works when Forms Tear-Off is turned off (deactivated in the printer menu).

When Forms Tear-Off is turned on (activated in the printer menu), and you attempt Manual Forms Tear-Off, the printer retracts the paper to the Top of Form position.

- ! **DO NOT use Forms Tear-Off with labels or multi-part forms!**
- ! **Forms Tear-Off CANNOT be used when the optional pull tractor is engaged.**

- 1 Press **TEAR** (1) to advance continuous-form paper up to the tear position.

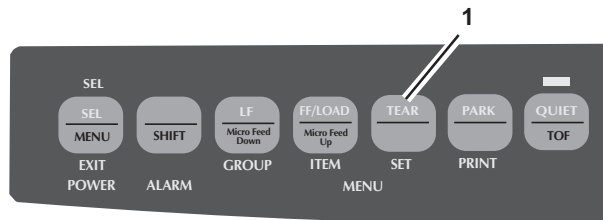

# TEAR Key

## Forms Tear-Off set OFF

If you press TEAR (1) when Forms Tear-Off is turned off (deactivated in the printer menu), the printer advances continuous-form paper up to the tear position.

Manual Forms Tear-Off allows you to advance a single page to the tear-off position.

Manual Forms Tear-Off works when Forms Tear-Off is turned off (deactivated in the printer menu).

- ! **Forms Tear-Off CANNOT be used when the optional pull tractor is engaged.**

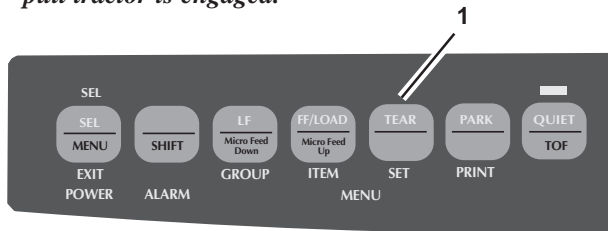

## Forms Tear-Off set ON

If you press TEAR (1) when Forms Tear-Off is turned on (activated in the printer menu), the printer retracts the paper to the Top of Form position.

- ! **Forms Tear-Off CANNOT be used when the optional pull tractor is engaged.**

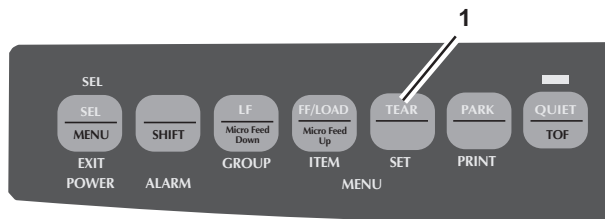

## Paper Park

! *Never park labels!*

Paper park allows you to print a single sheet (cut-sheet) page without removing continuous feed paper from the printer.

Press PARK (1) to retract rear-feed paper from the paper path.

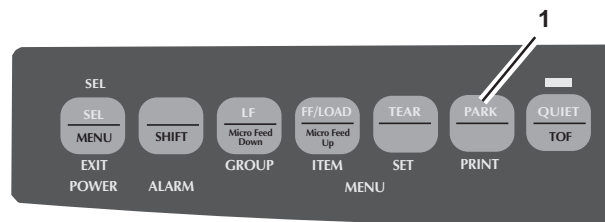

# Changing Paper Paths

## Continuous-forms to single-sheet feed

- 1 Tear off any printed pages.
- 2 Press PARK.
- 3 Raise the paper separator to the single-sheet feed position.
- 4 Place the wire feed guide in the paper separator.
- 5 Move the paper lever to the position marked “TOP.”  
The paper lever is towards the back of the printer.
- 6 Place a sheet of paper in the paper separator.

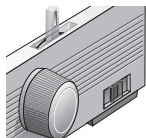

## Single-sheet feed to continuous forms

- 1 Press FF/LOAD to remove the single-sheet paper.
- 2 Lower the paper separator into the continuous-forms position. Swing the wire feed guide over onto the pull-up roller.
- 3 Move the paper lever to the appropriate position  
For rear feed (1), the paper lever is towards the front of the printer.  
For bottom feed, (2), the paper lever is in the center position.
- 4 If necessary, load continuous-form paper.
- 5 Press FF/LOAD.

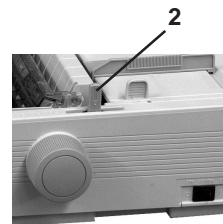
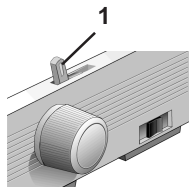

## Printhead Gap

The printhead gap is the distance between the printhead and the platen.

- ! **Make sure the printer is turned off before you open the access cover.**
- **access cover.**

To adjust the gap, open the access cover and move the blue lever (1) to the recommended setting from the table.

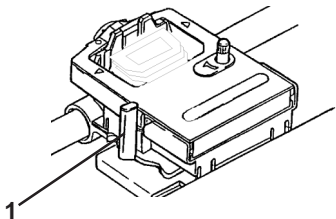

Media	Setting
12-20 lb paper	1
20-24 lb bond paper	2
Labels	3 or 4
Envelopes	4 or 5
2-part form (with carbon)	1 or 2
3-part form (with carbon)	2 or 3
4-part form (with carbon)	3 or 4
5-part form (with carbon)	4 or 5
6-part form (with carbon)	5

- ! **For dedicated, bottom-feed printing of extra-thick continuous forms (requires optional push and/or pull tractor), the printhead gap range can be expanded to take forms up to 0.031" (0.79 mm) thick. For more information, refer to "Using Your Printer, Printhead Gap, Expanded Printhead Gap."**

## Expanded Printhead Gap

Your printer can be used for dedicated bottom-feed printing on extra-thick multi-part forms. Extra-thick multi-part forms range from 0.017-inch (0.43 mm) to a maximum of 0.03 inch (0.79 mm). To print on extra-thick multi-part forms, you engage the expanded printhead gap feature. This expands the head gap settings for extra-thick forms and heavy card stock. It also increases the impact strength of the pins in the printhead.

- ! **CAUTION!** *Once the expanded printhead gap is engaged, you cannot print on single sheets without changing the gap back. If you try to print on single sheets without adjusting the printhead gap, you can damage the printhead and void your warranty. To disengage the expanded printhead gap, reverse the following steps.*

To engage the expanded printhead gap:

- 1 Turn the printer off.
- 2 Remove the access cover and the pull-up roller assembly.

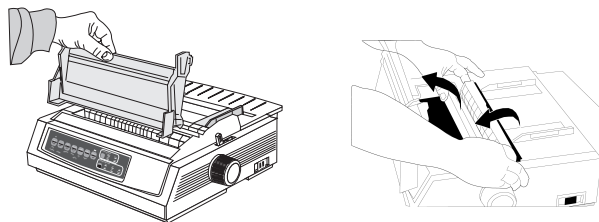

- 3 Move the printhead to the center of the platen.
- 4 Remove the ribbon cartridge.

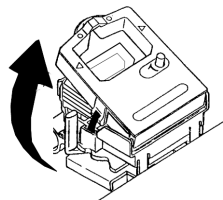

- 5 Swing up the printhead clamp, then remove it by pushing forward (toward the platen) and to the left.

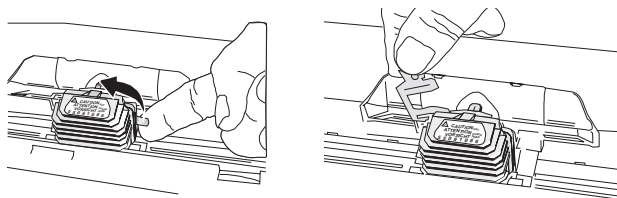

- 6 Remove the printhead.

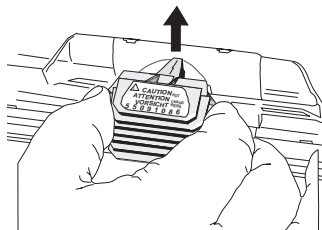

- 7 Lift the printhead plate off the carriage assembly (1).

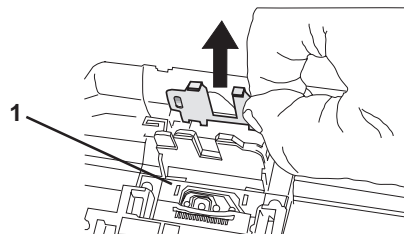

- 8 Turn the printhead plate around and reinsert it on the other side of the carriage assembly (1).

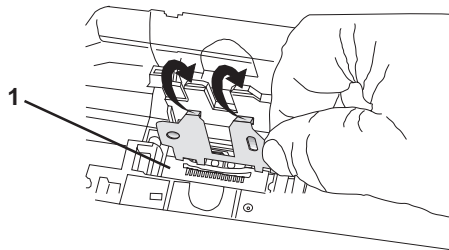

- 9 Replace the printhead, making sure that the circuit board at the bottom of the printhead firmly engages the slot (1) in the carriage.

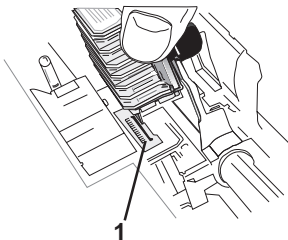

- ! **CAUTION!** Be sure the printhead is fully inserted before proceeding.

- 10 Reinstall the printhead clamp and swing it back over to lock the printhead in place.

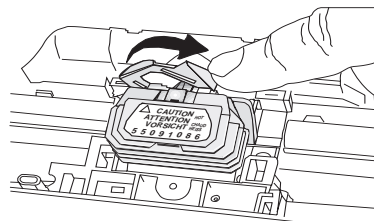

- ! **Important!** The clamp must be between the black projection on the printhead and the metal plate on the carriage, on both sides.



**11** Reinstall the ribbon cartridge.

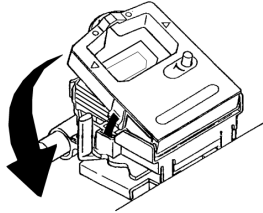

**12** Replace the pull-up roller assembly and the access cover, then turn the printer on.

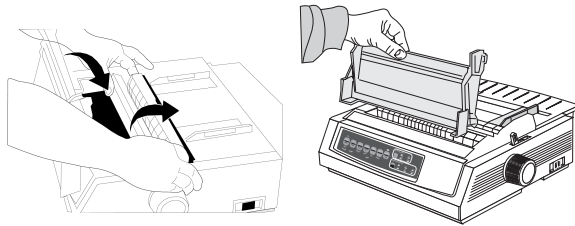

**13** Change the printer's secondary menu (make sure paper is loaded!) to engage the expanded printhead gap:

- a) Press SEL + TEAR while turning the printer back on.
- b) Press LF to advance through the menu to the Technical group (last option in menu).
- c) Press FF/LOAD to advance through the items to Expanded Gap.
- d) Press TEAR to change the setting for Expanded Gap to Valid.
- e) Press SHIFT + MENU to exit the menu and save your setting.

## Print Quality

- ! **Important!**
- *Front panel settings for print quality and character pitch are overridden by software commands. The lights will always reflect the printer's state.*



Press PRINT QUALITY to select:

### **NLQ: Near Letter Quality**

- Highest quality, slowest speed
- Courier or Gothic fonts
- Recommended for correspondence

### **UTL: Utility**

- Medium quality, medium speed
- Gothic font only
- Recommended for internal documents and high-volume data.

### **HSD: High Speed Draft**

- Lower quality, faster speed
- Gothic font only
- Recommended for drafts.

### **SSD: Super Speed Draft**

- Lowest quality (12 cpi only), fastest speed
- Gothic font only
- Recommended for fastest output of drafts.

## Super Speed Draft

To use Super Speed Draft (SSD), enter the Menu Mode and make changes as follows:

- 1 Press SHIFT + SEL.
- 2 Press GROUP twice.
- 3 Press SET until DRAFT prints as the setting for the Print Mode.
- 4 Press ITEM.
- 5 Press SET (SSD prints).
- 6 Press SHIFT + SEL to exit Menu Mode and save your changes.

## Printer Reset

When you reset the printer, you reinitialize it.

You will need to reset the printer to clear some error conditions

To reset the printer:

- 1 Press and release the SEL key to take the printer off-line. The SEL light will be out.
- 2 Then, press and hold the SHIFT key and press the RESET (CHARACTER PITCH) key.
- 3 The printer is reset.



### ***Important!***

- ***A printer reset is NOT the same as a reset to factory defaults.***

***A printer reset reinitializes the printer, but does NOT affect any menu settings.***

***A reset to factory defaults returns ALL menu settings to the factory defaults.***

## Character Pitch

Press CHARACTER PITCH/RESET to select the width of characters in characters per inch, or Proportional.

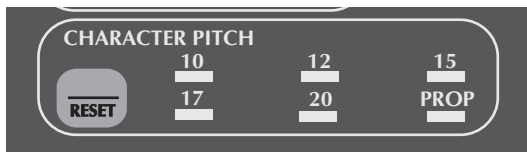

### 10 cpi

- Recommended for standard text
- Not available for SSD

### 12 cpi

- Recommended for standard text
- Yields more text per page

### 15 cpi

- Recommended for spreadsheets
- Yields more text per page

### 17.1 cpi, 20 cpi

- Recommended for spreadsheets
- Smallest print
- Not available for SSD

### PROP

- Recommended for a more polished appearance
- Proportional spacing
- NLQ and Utility only

## Menu Mode

- ! **ALWAYS print the current Menu Mode settings before you reset or change the Menu settings.**
- **Printing the settings is the only way to have a record of the settings.**

*To print the Menu Mode Settings, refer to “Using Your Printer, Menu Mode, Printing the Menu Settings.”*

In Menu Mode, you use the front panel keys to change the defaults for the printer parameters. The changes you make in the Menu Mode are automatically saved when you exit the Menu Mode and are retained, even when you turn the printer off.

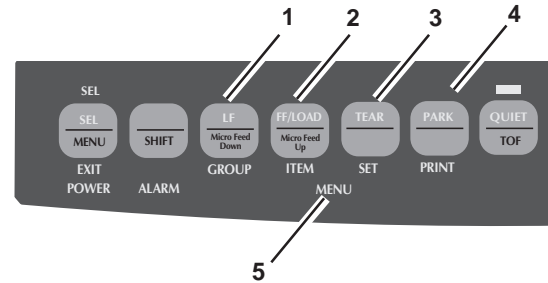

- 1 GROUP:** Prints the next Group in the Menu. With the SHIFT key, prints the previous Group.
- 2 ITEM:** Prints next Item in the Group. With the SHIFT key, prints previous Item in the Group.
- 3 SET:** Prints next Setting for an Item. With the SHIFT key, prints previous Setting for an Item.
- 4 PRINT:** Prints a copy of all the Menu settings. With the SHIFT key, prints the current settings for the Group selected.
- 5 MENU light:** Glows when the printer is in the Menu Mode.

## Entering and Exiting Menu Mode

To enter or exit the Menu Mode, hold SHIFT while pressing SEL.

## Moving Through the Menu

When the printer is in Menu Mode, you can move forward or backwards through the menu.

### Moving Forward

To move forward, press GROUP, ITEM, or SET, whichever is appropriate.

For more information, refer to “Using Your Printer, Menu Mode.”

### Moving Backward

To move backward, press and hold SHIFT, then GROUP, ITEM, or SET, whichever is appropriate.

For more information, refer to “Using Your Printer, Menu Mode.”

## Resetting Menu to Factory Defaults

- ! ***ALWAYS print the current Menu Mode settings before you reset or change the Menu settings.***
  - ***Printing the settings is the only way to have a record of the settings.***
- To print the Menu Mode Settings, refer to “Using Your Printer, Menu Mode, Printing the Menu Settings.”***

To reset the Menu to the standard settings (factory defaults):

- 1 Turn the printer off.
- 2 Press SEL + LF while turning the printer on.

## Printing the Menu Settings

- ! ***ALWAYS print the current Menu Mode settings before you reset or change the Menu settings.***
- ***Printing the settings is the only way to have a record of the settings.***

- 1 Make sure paper is loaded in the printer.
- 2 Enter the Menu Mode (SHIFT + SEL).
- 3 Press PRINT (PARK key).

- ! ***To print out a listing of the settings for all menu items, regardless of the emulation selected or the accessories installed, enter the Menu Mode, then press SHIFT + PRINT QUALITY.***

## Changing the Menu Settings

- ! ***ALWAYS print the current Menu Mode settings before you reset or change the Menu settings.***
- ***Printing the settings is the only way to have a record of the settings.***

***To print the Menu Mode Settings, refer to “Using Your Printer, Menu Mode, Printing the Menu Settings.”***

- 1 Press SHIFT + SEL to enter the Menu Mode.
- 2 Use the GROUP, ITEM and SET keys to make your changes:  
Press GROUP until the Group you wish to change appears in the first column.  
Press ITEM until the Item you wish to change appears in the second column.  
Press SET until the setting you want appears in the third column.
- 3 Press SHIFT + SEL to exit the Menu Mode and save your settings.

- ! ***Important!***
- ***If you turn off the printer without first exiting the Menu Mode, the changes you have made will be lost.***



## Menu Settings Table

For a complete explanation of each menu item, refer to “Using Your Printer, Menu Mode, Explanations of Menu Items.”

The table below shows the items which may appear in the menu. Settings which are engaged at the factory (defaults) are set in ***bold italic***. Some groups or entries will only appear when a specific emulation is engaged, as noted.

<b>Group</b>	<b>Item</b>	<b>Settings</b> (Defaults are set in <b><i>bold italic</i></b> )
Printer Control	Emulation Mode	<b><i>IBM PPR</i></b> , EPSON FX, ML
Font	Print Mode	<b><i>Utility</i></b> , NLQ Courier, NLQ Gothic, Draft
	Draft Mode	<b><i>HSD</i></b> , SSD
	Pitch	<b><i>10 cpi</i></b> , 12 cpi, 15 cpi, 17.1 cpi, 20 cpi
	Proportional Spacing	<b><i>No</i></b> , Yes
	Style	<b><i>Normal</i></b> , Italics
	Size	<b><i>Single</i></b> , Double
Symbol Sets	Character Set	<b><i>Standard</i></b> , Line Graphics, Block Graphics
	Language Set	<b><i>American</i></b> , French, German, British, Danish I, Swedish, Italian, Spanish I, Japanese, Norwegian, Danish II, Spanish II, Latin American, French Canadian, Dutch, Publisher
	Zero Character	<b><i>Slashed</i></b> , Unslashed
	Code Page	<b><i>USA</i></b> , Canada French, Multilingual, Portugal, Norway, BRASC II, Abicom

## Menu Settings Table (Continued)

For a complete explanation of each menu item, refer to “Using Your Printer, Menu Mode, Explanations of Menu Items.”

The table below shows the items which may appear in the menu. Settings which are engaged at the factory (defaults) are set in ***bold italic***. Some groups or entries will only appear when a specific emulation is engaged, as noted.

<b>Group</b>	<b>Item</b>	<b>Settings</b> (Defaults are set in <b><i>bold italic</i></b> )
Rear Feed	Line Spacing	<b><i>6 LPI</i></b> , 8 LPI
	Form Tear-Off	<b><i>Off</i></b> , 500 mS, 1 sec, 2 sec
	Skip Over Perforation	<b><i>No</i></b> , Yes
	Page Width (wide model only)	<b><i>13.6"</i></b> , 8"
	Page Length	<b><i>11"</i></b> , 11-2/3", 12", 14", 17", 3", 3.5", 4", 5.5", 6", 7", 8", 8.5"
Bottom Feed	Line Spacing	<b><i>6 LPI</i></b> , 8 LPI
	Form Tear-Off	<b><i>Off</i></b> , 500 mS, 1 sec, 2 sec
	Skip Over Perforation	<b><i>No</i></b> , Yes
	Page Width (wide model only)	<b><i>13.6"</i></b> , 8"
	Page Length	<b><i>11"</i></b> , 11-2/3", 12", 14", 17", 3", 3.5", 4", 5.5", 6", 7", 8", 8.5"

## Menu Settings Table (Continued)

For a complete explanation of each menu item, refer to “Using Your Printer, Menu Mode, Explanations of Menu Items.”

The table below shows the items which may appear in the menu. Settings which are engaged at the factory (defaults) are set in **bold italic**. Some groups or entries will only appear when a specific emulation is engaged, as noted.

Group	Item	Settings (Defaults are set in <b>bold italic</b> )
Top Feed	Line Spacing Bottom Margin Page Width (wide model only) Page Length Wait Time Page Length Control	<b>6 LPI</b> , 8 LPI <b>Valid</b> , Invalid <b>13.6"</b> , 8" <b>11"</b> , 11-2/3", 12", 14", 17", 3", 3.5", 4", 5.5", 6", 7", 8", 8.5" 500 mS, 1 sec, 2 sec <b>By MENU Setting</b> , By Actual Page Length
Set-Up	Graphics 7 or 8 Bit Graphics* Receive Buffer Size Paper Out Override Print Registration	<b>Bi-directional</b> , Uni-directional <b>8</b> , 7 <b>1 Line</b> , 16K, 28K, 64K <b>No</b> , Yes <b>0</b> , set in 0.05 mm increments: press SEL to shift registration to the left; press SHIFT + SEL to shift registration to the right.

\* Appears only when the MICROLINE Standard emulation is selected.

## Menu Settings Table (Continued)

For a complete explanation of each menu item, refer to “Using Your Printer, Menu Mode, Explanations of Menu Items.”

The table below shows the items which may appear in the menu. Settings which are engaged at the factory (defaults) are set in **bold italic**. Some groups or entries will only appear when a specific emulation is engaged, as noted.

Group	Item	Settings (Defaults are set in <b>bold italic</b> )
Set-Up (continued)	7 or 8 Bits Data Word*	<b>8, 7</b>
	Operator Panel Function	<b>Full Operation</b> , Limited Operation
	Reset Inhibit	<b>No</b> , Yes
	Print Suppress Effective	<b>Yes</b> , No
	Auto LF	<b>No</b> , Yes
	Auto CR+	<b>No</b> , Yes
	Print DEL Code*	<b>No</b> , Yes
	SI Select Pitch (10 cpi)+	<b>17.1 cpi</b> , 15 cpi
	SI Select Pitch (12 cpi)+	<b>20 cpi</b> , 12 cpi
	Time Out Print	<b>Valid</b> , Invalid
	Auto Select	<b>No</b> , Yes
	Centering Position	<b>DEFAULT</b> , MODE 1, MODE 2
ESC SI Pitch	<b>17.1 cpi</b> , 20 cpi	

\* Appears only when the MICROLINE Standard emulation is selected.

+ Appears only when the IBM emulation is selected.

## Menu Settings Table (Continued)

For a complete explanation of each menu item, refer to “Using Your Printer, Menu Mode, Explanations of Menu Items.”

The table below shows the items which may appear in the menu. Settings which are engaged at the factory (defaults) are set in ***bold italic***. Some groups or entries will only appear when a specific emulation is engaged, as noted.

<b>Group</b>	<b>Item</b>	<b>Settings</b> (Defaults are set in <b><i>bold italic</i></b> )
Parallel I/F	I-Prime Pin 18 Auto Feed XT**	<b><i>Buffer Print</i></b> , Invalid, Buffer Clear +5V, Open <b><i>Invalid</i></b> , Valid

\*\* Applies only when the Epson emulation is selected.

## Explanations of Menu Items

Refer to “Using Your Printer, Menu Mode, Menu Settings Table” for an overview of the menu structure.

**7 or 8 Bits Data Word (ML).** If your computer system uses seven bits to make up each unit of data, change this setting to 7.

**7 or 8 Bit Graphics (ML).** Choose the graphics your system uses: 7 or 8 dots in each column printed.

**Auto CR (IBM).** If you want the printer to automatically add a carriage return when a Line Feed is received at the end of a line, change the setting to Yes.

**Auto LF.** If your printout is consistently double spaced, select No; if it overprints, select Yes.

**Auto Feed XT (Epson).** If your system uses pin 14 of the parallel interface to control automatic line feed, change the setting to Valid.

**Auto Select.** If you always use the same Top of Form position, change the setting to Yes.

**Bottom Margin.** Change to Invalid if you want the printer to ignore the bottom margin setting. Caution!! This can cause loss of data and damage the printhead.

**Centering Position.** Used to limit printhead travel when printing narrow columns.

Select Mode 1 for the narrow carriage printer.

Select Mode 1 or Mode 2 for the wide carriage printer.

**Character Set.** Choose Standard (IBM Set I), Line Graphics (IBM Set II) or Block Graphics.

**Code Page.** Choose the Code Page character set you wish to use: USA (IBM 437), Canada French (IBM 863), Multilingual (IBM 850), Portugal (IBM 860), Norway (IBM 865), BRASC II, or Abicomp.

**Draft Mode.** Change to SSD if you wish to use the Super Speed Draft mode of printing. Note: Print Mode must be set to DRAFT for this setting to be effective.

**Emulation Mode.** Choose the printer emulation.

**ESC SI Pitch.** Sets the character pitch used when the ESC SI command is received.

## Explanations of Menu Items (Continued)

Refer to “Using Your Printer, Menu Mode, Menu Settings Table” for an overview of the menu structure.

**Form Tear-Off.** Choose 500 mS, 1 sec, or 2 sec to turn the Form Tear-Off feature on and to set the time interval for the printer to wait before advancing the paper.

**Graphics.** Change to bi-directional graphics for faster printing. Optimize the registration using the Print Registration setting in the Menu.

**I-Prime.** Determines what the printer will do when it receives the I-Prime signal from the software.

Buffer Print prints out the buffer contents before resetting.

Buffer Clear dumps the buffer contents immediately.

Invalid causes the printer to ignore the I-Prime command.

**Language Set.** Replaces certain standard symbols with special characters used in foreign languages.

**Line Spacing.** Change to 8 lines per inch to get more lines on a page.

**Operator Panel Function.** Change to Limited Operation to deactivate the PRINT QUALITY and CHARACTER PITCH buttons. This prevents these from being changed from the control panel when several people are using the printer.

**Page Length.** Selects the length of the paper you are using.

**Page Width (Wide Carriage only).** Change to 8" to print on letter-size paper.

**Paper Out Override.** Senses when less than 1" (25 mm) of paper remains and stops printing. Change to Yes to override the sensor. Caution!! This can cause loss of data and damage the printhead!

**Pin 18.** Sets the signal on pin 18 to +5 volts or to open.

**Pitch.** Choose the character width, in character per inch (cpi).

**Print DEL Code (ML).** Change to Yes if you wish to print the DEL code (decimal 127) as a solid box.

**Print Mode.** Choose the quality and speed of printing.

**Print Registration.** Change the setting as required to obtain the best registration for bi-directional printing.

## Explanations of Menu Items (Continued)

Refer to “Using Your Printer, Menu Mode, Menu Settings Table” for an overview of the menu structure.

**Print Suppress Effective.** If your system uses the DC1 and DC3 codes for something other than the print suppress mode, change the setting to No.

**Proportional Spacing.** Change the setting to Yes to engage proportional spacing of characters.

**Receive Buffer Size.** Selects the amount of memory devoted to holding received data. Choosing 1 Line will tie up your computer while printing, but if you abort the print job, the printer will stop much sooner.

**Reset Inhibit.** Select Yes to prevent your software from resetting your printer's settings.

**SI Select Pitch, 10 cpi (IBM).** Sets the pitch to be engaged when the printer control panel is set for 10 cpi and the SI command is received.

**SI Select Pitch, 12 cpi (IBM).** Sets the pitch to be engaged when the printer control panel is set for 12 cpi and the SI command is received.

**Size.** Change to Double for double width and height printing.

**Skip Over Perforation.** Change to Yes if you want the printer to go to the next page when it comes within 1" (25 mm) of the bottom of the page. Keep it set to No if your software has its own page formatting controls.

**Style.** Change to italics if you want the printed characters to be slanted.

**Time Out Print.** If your software spends a long time processing between portions of data it feeds to the printer, change the setting to Invalid to keep your printer from dumping the received data while it is waiting for more.

**Wait Time.** Sets the amount of time the printer will wait for more data before moving to the form tear-off position.

**Zero Character.** If you do not want the printer to use a slash to distinguish the number zero from the capital letter O, change the setting to Unslashed.



# Maintenance

## Replacing the Ribbon Cartridge

If you need instructions for replacing the ribbon cartridge, you can refer to the

- packaging of the new cartridge
- web site
- “Installation, Ribbon Cartridge.”

For the best results, use genuine OKI ribbons.

For information on obtaining consumables, refer to “Accessories.”

For information on the web site, refer to “Service and Support, Internet Support.”

## Printer Cleaning

You should clean the printer every six months (or after about 300 hours of operation).

! *Never use solvents or strong detergents on the cabinet: they could cause damage.*

- 1 Turn off the printer. Then, use the platen knob to back the paper out of the printer.
- 2 Open the access cover. Remove the pull-up roller assembly.

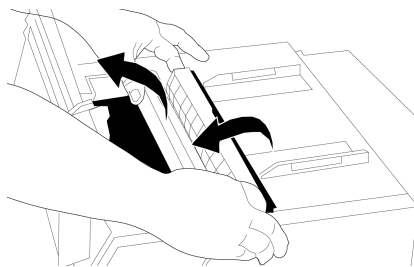

- 3 Use a clean, dry cloth to dust around the carriage shaft and platen. Remove any loose bits of paper.
- 4 Install the pull-up roller assembly. Close the access cover.

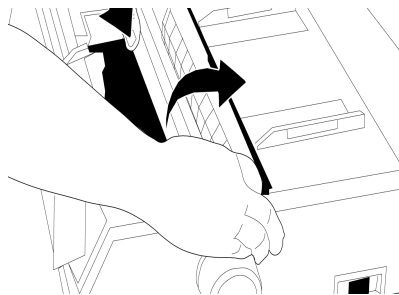

# Paper Jams

## Rear-Feed Paper Jams

- 1 Turn off the printer. Then, use the platen knob to back the paper out of the printer.

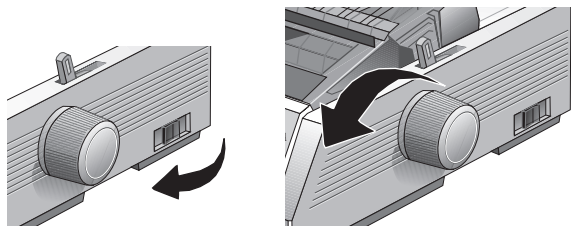

- ! *Make sure the printer is turned off before you open the access cover.*

- 2 Open the access cover. Remove the pull-up roller assembly.

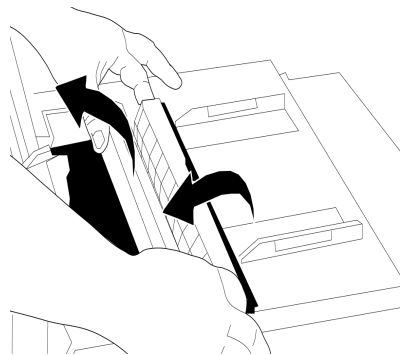

- 3 Remove any torn pieces of paper.
- 4 Grasp the tabs and lift off the paper separator. Load paper.

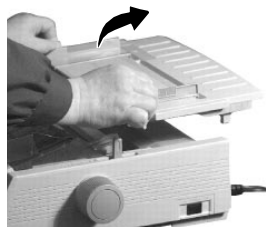

- 5 Install the paper separator. Install the pull-up roller assembly. Close the access cover.

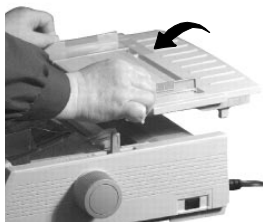

- 6 Turn on the printer.

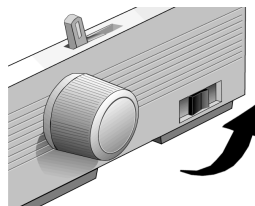

- 7 Press FF/LOAD.



## Rear-Feed, Repeating Paper Jams

If the paper keeps jamming, you probably have bits of paper stuck in the paper path.

- 1 Turn off the printer. Then, use the platen knob to back the paper out of the printer.
- 2 Open the access cover. Remove the pull up roller assembly. Remove any torn pieces of paper.

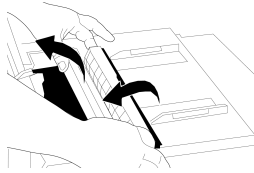

- 3 Grasp the tabs and lift off the paper separator.

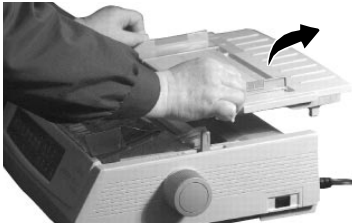

- 4 Fold some continuous-form paper over three times to make a page four sheets thick. Then, load it on the tractors and close the covers.

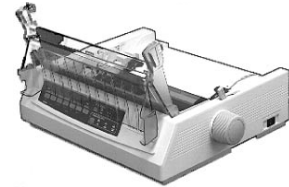

- 5 Use the platen knob to draw the quadruple-thick page around the platen. This clears any jammed bits of paper.

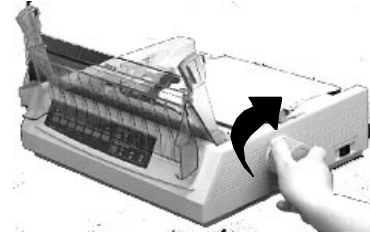

**6** Remove any paper pieces. Then, use the platen knob to back the paper out.

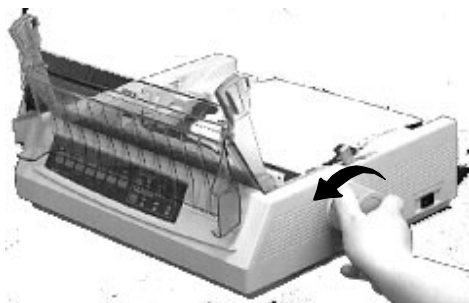

**7** Load regular paper. Install the paper separator.

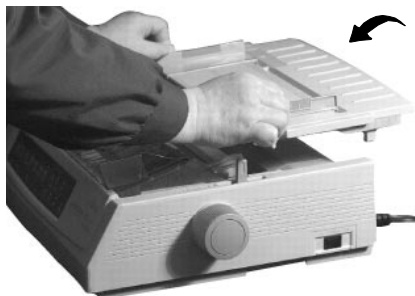

**8** Install the pull-up roller assembly. Close the access cover.

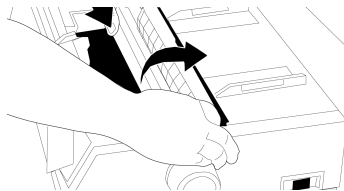

**9** Turn on the printer.

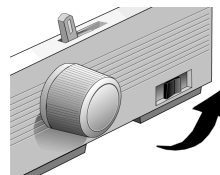

**10** Press FF/LOAD.



## Single-Sheet Paper Jams

- 1 Turn off the printer.
- 2 Then, use the platen knob to back the paper out.

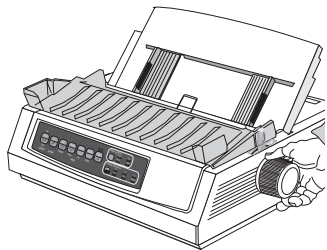

- 3 Open the access cover. Remove the pull-up roller assembly.

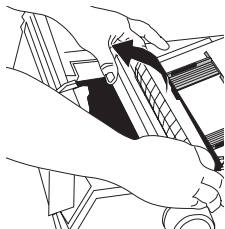

- 4 Remove any torn pieces from around the carriage.
- 5 Install the pull-up roller assembly. Close the access cover.

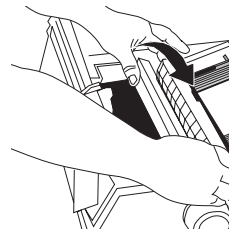

- 6 Turn on the printer. Load paper.

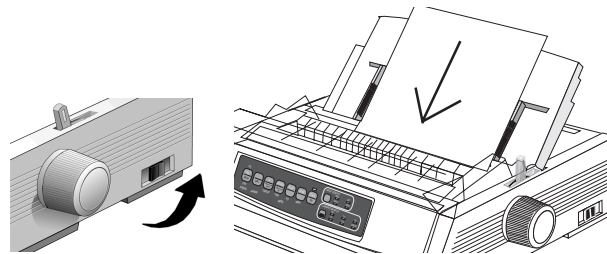

# Troubleshooting

## General Information

Here are some general things to check before proceeding with detailed troubleshooting.

- Is the printer plugged in and turned on?
- Are the connections (power and interface) secure?
- Is the product being operated under the proper ambient conditions?
- Does the paper being used meet the specifications for this product?
- Is the paper properly installed?
- Has the ribbon been replaced as recommended?
- Is the ribbon properly installed?
- Is an OKI ribbon being used?
- Is the printhead gap correctly set?
- Are the correct printer drivers being used for the printer?

- ! *Settings in your software application will override any settings in your printer driver.*
- *Your printer driver settings will override any settings from the printer menu or printer front panel.*

## Internet Support

Oki Data provides support via the Internet.

Oki Data's main web site, [www.okidata.com](http://www.okidata.com), is the gateway to Oki Data's products and services.

[my.okidata.com](http://my.okidata.com) is a powerful area of Oki Data's web site designed to help you personalize the information and service you get from Oki Data.

For more information, refer to "Service and Support, Internet Support."



## List of Problems

### **Problem 1:**

My word processor files do not print the way I have the menu and front panel set.

### **Problem 2:**

Nothing happens when I turn on the printer.

### **Problem 3:**

The printer does not print when the computer sends data.

### **Problem 4:**

I'm getting strange symbols, incorrect fonts, etc., when I try to print a document.

### **Problem 5:**

Ink smears on the paper when I print on narrow forms.

### **Problem 6:**

I've installed a new ribbon and the printing is smeared and streaked.

### **Problem 7:**

The ALARM light is flashing.

### **Problem 8:**

The ALARM light is on and the Character Pitch 10 light is flashing.

### **Problem 9:**

The ALARM light is on and the Character Pitch 15 light is flashing.

### **Problem 10:**

The printer needs paper, but the ALARM light is not on and I cannot load the paper.

### **Problem 11:**

The Print Quality and Character Pitch keys on the front panel don't work.

### **Problem 12:**

Continuous-form paper sticks to the paper separator.

**Problem 1:**

*My word processor files do not print the way I have the menu and front panel set.*

**Solution:**

Always remember that:

- 1 Settings in your software application will override any settings in your printer driver.
- 2 Your printer driver settings will override any settings from the printer menu or printer front panel.

**Solution:**

Before sending a file to the printer, many word processors send either an “initialization string” or an I-Prime signal to the printer.

The initialization string contains codes that override the panel and menu settings. To change your printer to ignore the reset code, enter the Menu Mode, go to the Set-Up group and change the setting for Reset Inhibit to Yes. Refer to “Using Your Printer, Menu Mode.”

The I-Prime signal will automatically override any front panel settings you have made. To eliminate this problem, enter the Menu Mode, go to the Parallel Interface group and change the setting for I Prime to Invalid. Refer to “Using Your Printer, Menu Mode.”

**Problem 2:**

*Nothing happens when I turn on the printer.*

**Solution:**

Check the power cord connection to the outlet. If you are using a power strip, make sure it is turned on, and that a fuse hasn't blown or that a circuit breaker hasn't tripped.

**Problem 3:**

*The printer does not print when the computer sends data.*

**Solutions:**

- 1 Is the SEL light on? If not, press the SEL key.
- 2 Check that the interface cable is securely connected to both the printer and the computer.
- 3 If you have the optional serial interface board installed, check to be sure that it is firmly seated in the printer.

**Problem 4:**

*I'm getting strange symbols, incorrect fonts, etc., when I try to print a document.*

**Solutions:**

- 1 Check to be sure that the printer driver you have selected in your software matches the printer emulation.  
Press SHIFT and SEL keys, then press GROUP key.  
This will print a line showing the emulation you have selected.
- 2 If you have embedded any printer commands in your software, check to be sure that you entered them correctly.

**Problem 5:**

*Ink smears on the paper when I print on narrow forms.*

**Solution:**

This may be caused by excessive printhead travel from the centering position. Enter the Menu and set the Centering Position to MODE 1. Refer to “Using Your Printer, Menu Mode.”

For the wide-carriage printer, if MODE 1 doesn't work, try setting the Centering Position to MODE 2.

**Problem 6:**

*I've installed a new ribbon and the printing is smeared and streaked.*

**Solution:**

The ribbon shield is either loose or missing. Remove the ribbon cartridge and check the ribbon shield.

If it is loose, secure it.

If it is missing, find it and install it.

**Problem 7:**

*The ALARM light is flashing.*

**Solution:**

Try turning the printer off and then back on again. If the light still blinks, call for service.

**Problem 8:**

*The ALARM light is on and the Character Pitch 10 light is flashing.*

**Solution:**

This indicates that the paper lever is set at the wrong position for the paper you are trying to use. Move it to the proper setting.

**Problem 9:**

*The ALARM light is on and the Character Pitch 15 light is flashing.*

**Solution:**

This indicates a paper jam. Press the SEL key and correct the paper jam situation. Refer to “Maintenance, Paper Jams.”

**Problem 10:**

*The printer needs paper, but the ALARM light is not on and I cannot load the paper.*

**Solution:**

Press and release the SEL key.

Then, press and hold the SHIFT key and press the RESET (CHARACTER PITCH) key.

The printer is reset.

**Problem 11:**

*The Print Quality and Character Pitch keys on the front panel don't work.*

**Solution:**

The Operator Panel Function in the printer menu can be used to disable these buttons (Limited Function). If the printer is part of a customized system or if it is used by a number of people, the system manager may have used this option to make sure the printer is always set properly.

Check with your system manager before changing any menu settings.

Refer to “Using Your Printer, Menu Mode.”

**Problem 12:**

*Continuous-form paper sticks to the paper separator.*

**Solution:**

In cold dry weather, static charges can build up and make the paper cling to the paper separator. Try moving the paper guides together so that the paper rests on the guides rather than on the separator.

# Specifications

! *Specifications subject to change without notice.*

## Print Method

Impact dot matrix

## Printhead

9 pins, 0.34 mm diameter, thermal protection

## Print Speed

### *Mode Characters per second*

Super Speed Draft (SSD) 435 cps

High Speed Draft (HSD) 390 cps

Utility (UTL) 300 cps

Near Letter Quality (NLQ) 75 cps

## Characters per Line (cpl)

<i>Setting</i>	<i>ML320 Turbo</i>	<i>ML321 Turbo</i>
10 cpi	80 cpl	136 cpl
12 cpi	96 cpl	163 cpl
15 cpi	120 cpl	204 cpl
17.1 cpi	137 cpl	233 cpl
20 cpi	160 cpl	272 cpl

## Emulations

Epson FX (ESC/P)

IBM Proprinter III(PPSII)

Oki Data Microline Standard co-resident

## Interface

Standard: Centronics parallel, IEEE-284 compliant

Optional: RS-232C serial

## Graphics Resolution

<i>Emulation</i>	<i>Maximum Resolution</i>
Epson/IBM	240 (H) x 216 (V) dpi
OKIDATA	288 (H) x 144 (V) dpi

## Resident Fonts

<i>Print Quality</i>	<i>Available Fonts</i>
Near Letter Quality	Courier, Gothic
Utility	Gothic
High Speed Draft	Gothic
Super Speed Draft	Gothic

## Resident Scalable Fonts\*

Courier and Gothic, in sizes from 22 to 216 points

\*Selectable through software only.

## Bar Codes

Code 39, UPC A, UPC E, EAN 8, EAN 13,  
Interleaved 2 of 5, Code 128, Postnet

## Receive Buffer Size

1 Line, 16 K, 28K, 64K

## Reliability

### Mean Time Between Failures (MTBF)

10,000 hours at 25% duty cycle and 35% page density

### Mean Time to Repair (MTTR)

15 minutes

## Printhead Life

200 million characters average in 10 cpi draft mode at 25%  
duty and 35% page density

## Ribbon Life

3 million characters, on average, 10 cpi utility

## Paper Specifications

### Microline 320 Turbo

**Paper Type:** Cut Sheet  
**Feed:** Top  
**Weight:** 14-24 lb. (52.5-90 g/m<sup>2</sup>)  
**Width Range:** 7.2" to 8.5" (182.8 to 215.9 mm)

**Paper Type:** Single-part, continuous forms  
**Feed:** Rear, Bottom  
**Weight:** 12-24 lb. (45-90 g/m<sup>2</sup>)  
**Width Range:** 3" to 10" (76.2 to 254 mm)

**Paper Type:** Carbonless continuous forms  
**Feed:** Rear, Bottom  
**Weight:** 9-11 lb. (33.75-41.25 g/m<sup>2</sup>)  
**Width Range:** 3-10" (76.2 to 254 mm)

**Paper Type:** Interleaf continuous forms  
**Feed:** Rear, Bottom  
**Weight:** Not applicable  
**Width Range:** 3-10" (76.2 to 254 mm)

**Paper Type:** Labels  
**Feed:** Bottom  
**Weight:** Not applicable  
**Width Range:** 3-10" (76.2 to 254 mm)

**Paper Type:** Envelopes, single feed  
**Feed:** Top  
**Weight:** 24 lb. max. (90 g/m<sup>2</sup>)  
**Width Range:** 6.5" to 9.5" (165.1 to 241.3 mm)

**Paper Type:** Envelopes, continuous feed, non-overlap  
**Feed:** Bottom  
**Weight:** 24 lb. max. (90 g/m<sup>2</sup>)  
**Width Range:** 6.5" to 9.5" (165.1 to 241.3 mm)

**Paper Type:** Card stock  
**Feed:** Bottom  
**Weight:** 120 lb. max. (450 g/m<sup>2</sup>)  
**Width Range:** Not applicable

**Paper Type:** Transparencies  
**Feed:** Top  
**Weight:** Not applicable  
**Width Range:** Not applicable

Standard Transparencies are  
8.5" x 11" (215.9 - 279.4 mm)



## Paper Specifications

### Microline 321 Turbo

<b>Paper Type:</b>	Cut Sheet
<b>Feed:</b>	Top
<b>Weight:</b>	14-24 lb. (52.5-90 g/m <sup>2</sup> )
<b>Width Range:</b>	7.2" to 14.3" (182.8 to 363.2 mm)
<b>Paper Type:</b>	Single-part, continuous forms
<b>Feed:</b>	Rear, Bottom
<b>Weight:</b>	12-24 lb. (45-90 g/m <sup>2</sup> )
<b>Width Range:</b>	3" to 16" (76.2 to 406.4 mm)
<b>Paper Type:</b>	Carbonless continuous forms
<b>Feed:</b>	Rear, Bottom
<b>Weight:</b>	9-11 lb. (33.75-41.25 g/m <sup>2</sup> )
<b>Width Range:</b>	3" to 16" (76.2 to 406.4 mm)
<b>Paper Type:</b>	Interleaf continuous forms
<b>Feed:</b>	Rear, Bottom
<b>Weight:</b>	Not applicable
<b>Width Range:</b>	3" to 16" (76.2 to 406.4 mm)
<b>Paper Type:</b>	Labels
<b>Feed:</b>	Bottom
<b>Weight:</b>	Not applicable
<b>Width Range:</b>	3" to 16" (76.2 to 406.4 mm)

<b>Paper Type:</b>	Envelopes, single feed
<b>Feed:</b>	Top
<b>Weight:</b>	24 lb. max. (90 g/m <sup>2</sup> )
<b>Width Range:</b>	6.5" to 9.5" (165.1 to 241.3 mm)
<b>Paper Type:</b>	Envelopes, continuous feed, non-overlap
<b>Feed:</b>	Bottom
<b>Weight:</b>	24 lb. max. (90 g/m <sup>2</sup> )
<b>Width Range:</b>	6.5" to 9.5" (165.1 to 241.3 mm)
<b>Paper Type:</b>	Card stock
<b>Feed:</b>	Bottom
<b>Weight:</b>	120 lb. max. (450 g/m <sup>2</sup> )
<b>Width Range:</b>	Not applicable
<b>Paper Type:</b>	Transparencies
<b>Feed:</b>	Top
<b>Weight:</b>	Not applicable
<b>Width Range:</b>	Not applicable
	Standard Transparencies are 8.5" x 11" (215.9 - 279.4 mm)

## Paper Thickness

### Rear Feed

0.014" (0.36 mm) maximum

### Bottom Feed\*

0.017" (0.43 mm) maximum  
expandable to 0.031" (0.79 mm) maximum

\* Requires optional push or pull tractor.

## Printer Dimensions

### Width x Depth x Height

#### ML320 Turbo

15.7 x 13.6 x 4.6 inches  
389 x 355 x 116 mm

#### ML321 Turbo

21.7 x 13.6 x 4.6 inches  
550 x 355 x 116 mm

## Printer Weight

ML320 Turbo: 17.2 lbs. (7.8 kg)

ML321 Turbo: 22.2 lbs. (10.1 kg)

## Environmental Requirements

### Temperature

Operating 41 to 104°F (5 to 40°C)

Storage 14 to 122°F (-10 to 50°C)

### Humidity

Operating 20 to 80% RH

Storage 5 to 95% RH

## Electrical Requirements

120 volts ac (+5.5%, -15%), 60 Hz (±2%)

Also available: 230 or 240 volts ac, 50 or 60 Hz (±2%)



*Specifications subject to change without notice.*

# Service and Support

## General Information

Oki Data offers service and support to you through a variety of methods.

Please choose the service and support method that is best for you.

Oki Data's service and support methods are:

- the documentation provided with your machine
- the store location where you purchased your machine
- Internet Support
- Telephone Support

Details of each support method are provided in this section.

Oki Data's service and support methods are different in these two areas:

- United States and Canada
- Latin America

Details for each area are provided in this section.

Service Centers are trained by Oki Data and are authorized to service OKI products. For more information about Service Centers, refer to "Service and Support, Service Centers."

## Documentation

The documentation provided with your machine provides an excellent reference for the day-to-day operation of your machine.

The documentation included with your machine is:

- User's Guide, on line, provided on the CD
- Microline Reference Manual, on line, provided on the CD
- Quick Start
- Warranty, Regulatory, and Safety Information

If you cannot locate your documentation, go to [www.okidata.com](http://www.okidata.com) or [www.my.okidata.com](http://www.my.okidata.com). Follow the prompts for your product, and you will find the on-line versions of all of these documents.

## Purchase Location

The store location where you purchased your machine provides an excellent, local means of support for you and your machine.

Your purchase location will also provide any warranty service required by your machine

- ! ***You will need your printer serial number if your machine requires servicing.***
- ***A written receipt for the product, showing the date of purchase, dealer's name, and both the model and serial numbers of the product must accompany any request or claim for work to be performed under Limited Warranty.***

# Internet Support

## **www.okidata.com**

### **Your Gateway to OKI Products and Services**

www.okidata.com is Oki Data's web site. It provides general information about all of the OKI products and services available to you.

You can use our web site to

- get Web-based support for all OKI products: 24 hours a day, 7 days a week—no waiting!
- download the printer drivers you need.
- read about other customers and how they use OKI products to improve their productivity and enhance their documentation.
- use the Dealer Locator to find a dealer location close to you.
- find out about Oki Data's special promotional offers and breaking news.
- and more . . .

## **my.okidata.com**

### **Your Personal Solutions Center**

my.okidata.com is a powerful area of Oki Data's web site designed to help you personalize the information and service you get from Oki Data.

When you register for my.okidata.com, you

- personalize the web-based support for the OKI products you own: 24 hours a day, 7 days a week—no waiting!
- automatically register your product.
- access on-line versions of your product documentation (manuals) and support information.
- control your contact, profile, and preference information.
- receive automatic notification of new printer drivers, key updates, and support information.
- track your e-mail support history.
- and more . . .

# Telephone Support

## **Oki Data Customer Information System Information System Automated Attendant**

1-800-654-3282 (1-800-OKI-DATA)

Toll Free in the U.S. and Canada

For quick answers to commonly-asked questions, the Oki Data Information System Automated Attendant is available 24 hours a day, 7 days a week. The system can provide immediate assistance with:

- Basic operating procedures
- Sales and service referrals
- Parts and consumable referrals
- Product information

## **Customer Support Professionals**

1-800-654-3282 (1-800-OKI-DATA)

Toll Free in the U.S. and Canada

Customer Support Professionals are available 24 hours a day, 7 days a week. Please be sure that you are calling from a telephone close to your machine so you can describe your problem accurately.

Our Customer Support Professionals are trained on all current OKI products. They can answer your questions regarding:

- Locations of sales and service dealers
- Installation of your machine
- Usage/normal maintenance of your machine
- Error message interpretation/solutions
- Parts and supplies identification
- Consumer relations

## Service Centers

### Authorized Service Providers

Oki Data has over 2,000 local Authorized Service Providers in North and South America.

For the most comprehensive, up-to-date listing of Oki Data authorized Service Centers:

- Consult our web site at [www.okidata.com](http://www.okidata.com)
- In the U.S. and Canada, call 1-800-654-3282 (1-800-OKI-DATA)
- In Latin America, contact the Latin America Service Coordinator at Oki Data's Corporate Headquarters at 856-222-7496 (Spanish only)

### United States

Oki Data Americas, Inc.  
2020 Bishops Gate Blvd.  
Mt. Laurel, NJ 08054  
Phone: 1-800-654-3282  
Fax: 1-856-222-5247

### Canada

Oki Data Americas, Inc.  
2735 Matheson Blvd. East, Unit 1  
Mississauga, Ontario  
Canada L4W 4M8  
Phone: 1-800-654-3282  
Fax: 1-905-238-4421

### Mexico

Oki Data de Mexico, S.A. de C.V.  
Mariano Escobedo No. 748-8 Piso  
Col. Anzures, e.p. 11590  
Mexico, DF  
Phone: (525) 263-8780  
Fax: (525) 250-3501

### Brazil

Oki Data do Brasil, Ltda.  
Rua Alexandre Dumas, 2220 - 8 andar  
Chácara Sto Antonio  
São Paulo, Brazil 04717-004  
Phone: 55-11-3444-3500  
Fax: 55-11-3444-3501

## **Service and Support: United States and Canada**

Oki Data is firmly committed to the satisfaction of our customers. If you have a problem that your customer documentation cannot solve, contact the listed sources for service or support.

## **Sales and Service Dealers: United States and Canada**

Consult the store location where you purchased your machine, or contact Oki Data for the location of the nearest Authorized Oki Data Service Dealer.

- Prices and minimum charges may vary.
- Proof of purchase is required for warranty work. Be sure to retain your purchase documents.



## Service and Support: Latin America

Oki Data is committed to offer the best customer support possible to our customers. In the instance of having a difficult problem with your OKI product, please contact any of the OKI- CAS (Centro Autorizado de Servicio) shown on our Web site, [www.okidata.com](http://www.okidata.com).

### Sales and Service Centers: Latin America

If you need to service your OKI product, please contact the store where you bought your fax machine or contact any of the OKI-CAS listed on our Web site for information.

- Prices and charges may vary.
- A copy of the proof of purchase is required for the warranty process.

### Contacting Oki Data: Latin America

Information regarding our products and authorized service centers is available in our Web site:

<http://www.okidata.com>

## Customer Support Professionals: Latin America

Our CAS's are trained and certified to provide the best service and support possible to our customers. Make sure that you are close to your machine when you call one of our OKI authorized service centers (OKI-CAS) so that you can describe your problem more accurately.

Our customer support professionals are trained on all current OKI products. They can answer your questions regarding:

- Location of nearest CAS (Service Center).
- Installation of your machine.
- Usage/normal maintenance of your machine.
- Error message interpretation/solutions
- Parts and supplies identification.
- Consumer relations.

# Accessories

## Purchasing Accessories

Before you purchase, know your machine model number (see the front of the unit) and have the correct part number and description of the item. Item descriptions and part numbers are provided in this section.

- Consult the dealer where you purchased your machine.
- Locate an Authorized Oki Data Reseller by visiting one of these web sites
  - <http://my.okidata.com>  
Allows you to register your product and personalize your own support needs
  - <http://www.okidata.com>  
Provides general information
- In the United States, purchase directly from Oki Data
  - Via the Internet
    - <http://my.okidata.com>
    - <http://www.okidata.com>
  - Via telephone
    - Order toll-free by phone at 1-800-654-3282 (1-800-OKI-DATA) using VISA, MasterCard, or American Express.
- In Canada, call 888-309-4570.

## Accessories: Part Numbers

### Consumables: Part Numbers

Consumable	Part Number
Ribbon Cartridge (1) -----	52102001

### Options: Part Numbers

Option	Part Number
<i>Model ML320T</i>	
Pull Tractor, Top-Mount (2) -----	70030501
Push Tractor, Bottom-Mount (3) -----	70030701
Roll Paper Stand (4) -----	70023301
<i>Model ML321T</i>	
Pull Tractor, Top-Mount (2) -----	70030601
Push Tractor, Bottom-Mount (3) -----	70030801
<i>Both Models</i>	
Cut Sheet Feeder (5) -----	70030101
(Cut Sheet Feeder sold only with printer; not available separately)	
Serial Interface (Not Shown) -----	70012801
OkiLAN 6010e 10 Base-T Ethernet External	
Print Server (Not Shown) -----	70034401
OkiLAN 6020e 10/100 Base-TX Ethernet External	
Print Server (Not Shown) -----	70036001

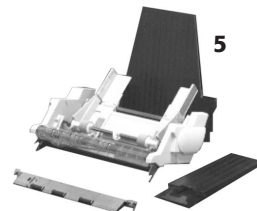
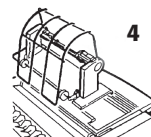
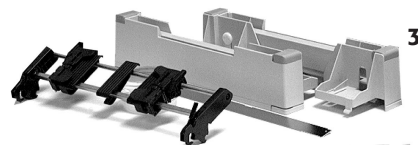
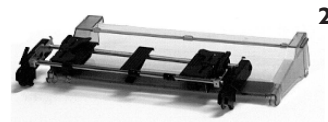
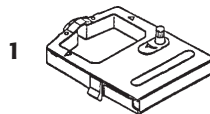

## Replacement Parts: Part Numbers

Replacement Part	Order No.
Access Cover, ML320T (1)	53076701
Access Cover, ML321T (1)	53076801
Acoustic Cover, ML320T (2)	53076901
Acoustic Cover, ML321T (2)	53077001
Platen Knob (3)	51902220
Power Cord (4)	56631801
Printhead (5)	50114601
Pull-Up Roller Assembly, ML320T (6)	50411001
Pull-Up Roller Assembly, ML321T (6)	50411101

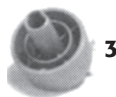
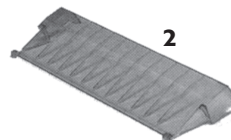
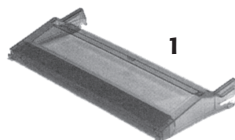

## Documentation: Part Numbers

Document	Part Number
Quick Start	refer to my.okidata.com
User's Guide	refer to my.okidata.com
Reference Manual	refer to my.okidata.com
Warranty, Regulatory, and Safety Information	refer to my.okidata.com

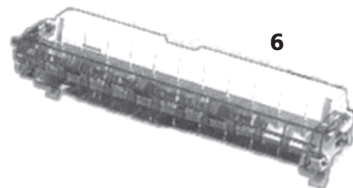
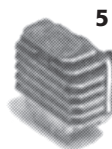

- ! **If you cannot locate your hardcopy documentation or the CD provided with your machine, go to [www.okidata.com](http://www.okidata.com) or [www.my.okidata.com](http://www.my.okidata.com). Follow the prompts for your product, and you will find the on-line versions of all of these documents.**

# Printer Control Codes

This section lists the most commonly used printer control codes.

The Microline Reference Manual provides complete lists of all the commands, along with information on their use.

You may view this document by:

- accessing the document on the CD provided with your machine
- using the Oki Data web sites  
<http://www.okidata.com>  
or  
[my.okidata.com](http://my.okidata.com)

! *The Microline Reference Manual is ONLY available in American English.*

## Epson FX Commands

Epson Command	ASCII	Decimal
Backspace	BS	8
Carriage Return, Execute	CR	13
Character Pitch		
Select 10 cpi	ESC P	27 80
Select 12 cpi	ESC M	27 77
Select 15 cpi	ESC g	27 103
Select Condensed Print	ESC SI, or SI	27 15, or 15
Cancel Condensed Print	DC2	18
Delete	DEL	127
Double Height On	ESC w 1	27 119 49
Double Height Off	ESC w 0	27 119 48
Double Width On	ESC W 1	27 87 49
Double Width Off	ESC W 0	27 87 48
Emphasized Print On	ESC E	27 69
Emphasized Print Off	ESC F	27 70
Enhanced Print On	ESC G	27 71
Enhanced Print Off	ESC H	27 72
Epson Set 1, Select	ESC t 0	27 116 48
Epson Set 2, Select	ESC t 1	27 116 49
Italic Printing On	ESC 4	27 52
Italic Printing Off	ESC 5	27 53
Form Feed	FF	12

Epson Command	ASCII	Decimal
Form Length		
n Inches (n = 1 to 22)	ESC C NUL n	27 67 0 n
n Lines (n = 1 to 255)	ESC C n	27 67 n
Horizontal Tab	HT	9
Justification		
Left	ESC a 0	27 97 48
Center	ESC a 1	27 97 49
Right	ESC a 2	27 97 50
Full	ESC a 3	27 97 51
Line Feed, Execute		
Select 10 cpi	ESC P	27 80
Select 12 cpi	ESC M	27 77
w/ Carriage Return	LF	10
n/216" (n = 0 to 255)	ESC J n	27 74 n
n/144" (n = 0 to 127)	ESC % 5 n	27 37 53 n
Reverse, n/216" (n = 0 to 255)	ESC j n	27 106 n
Line Spacing, Set		
n/144" (n = 0 to 127)	ESC % 9 n	27 37 57 n
n/216" (n = 0 to 255)	ESC 3 n	27 51 n
n/72" (n = 0-85 or 128-213)	ESC A n	27 65 n
1/6"	ESC 2	27 50
1/8"	ESC 0	27 48
7/72"	ESC 1	27 49

## Epson FX Commands (Continued)

Epson Command	ASCII	Decimal
Paper Out Sensor Off	ESC 8	27 56
Paper Out Sensor On	ESC 9	27 57
Print Quality/Font Select HSD/SSD, depending on Menu setting for Draft Mode	ESC ( 0	27 40 48
Select NLQ	ESC x 1	27 120 49
Select Courier (NLQ only)	ESC k 0	27 107 48
Select Gothic (NLQ only)	ESC k 1	27 107 49
Select UTL	ESC x 0	27 120 48
Print Speed Half-Speed On	ESC s 1	27 115 49
Half-Speed Off	ESC s 0	27 115 48
Print Suppress Mode On	DC3	19
Print Suppress Mode Off	DC1	17
Proportional Spacing On	ESC p 1	27 112 49
Proportional Spacing Off	ESC p 0	27 112 48
Reset Printer Clear Buffer & Initialize	ESC @	27 64
Clear Print Buffer	CAN	24
Skip Over Perforation, Cancel	ESC O	27 79
Software I-Prime	ESC } NUL	27 125 0

Epson Command	ASCII	Decimal
Subscript On	ESC S 1	27 83 49
Superscript On	ESC S 0	27 83 48
Subscript/Superscript Off	ESC T	27 84
Underline On	ESC - 1	27 45 49
Underline Off	ESC - 0	27 45 48
Uni-Directional Printing One Line Only	ESC <	27 60
On	ESC U 1	27 85 49
Off	ESC U 0	27 85 48
Vertical Tab, Execute	VT	11

## IBM Proprinter III Commands

IBM Command	ASCII	Decimal
Backspace	BS	8
Carriage Return	CR	13
Character Pitch		
Select 10 cpi	DC2	18
Select 12 cpi	ESC :	27 58
Select 15 cpi	ESC g	27 103
Select Condensed Print	ESC SI, or SI	27 15, or 15
Character Sets		
IBM Set I	ESC 7	27 55
IBM Set II	ESC 6	27 54
Publisher	ESC !Z	27 33 90
Slashed Zero	ESC !@	27 33 64
Unslashed Zero	ESC !A	27 33 65
Double Width On	ESC W 1	27 87 49
Double Width Off	ESC W 0	27 87 48
Emphasized Printing On	ESC E	27 69
Emphasized Printing Off	ESC F	27 70
Enhanced Printing On	ESC G	27 71
Enhanced Printing Off	ESC H	27 72
Form Feed	FF	12

IBM Command	ASCII	Decimal
Form Length, n inches (n = 1 to 22)	ESC C NUL n	27 67 0 n
Form Length, n lines (n = 1 to 255)	ESC C n	27 67 n
Horizontal Tab, Execute	HT	9
Italics On	ESC % G	27 37 71
Italics Off	ESC % H	27 37 72
Line Feed, Execute		
w/ Carriage Return	LF	10
n/144" (n = 1 to 127)	ESC % 5 n	27 37 53 n
n/216" (n = 0 to 255)	ESC J n	27 74 n
Reverse	ESC ]	27 93
Auto Line Feed On	ESC 5 1	27 53 49
Auto Line Feed Off	ESC 5 0	27 53 48



## IBM Proprinter III Commands (Continued)

IBM Command	ASCII	Decimal
Line Spacing		
Set Spacing to 1/8"	ESC 0	27 48
Set Spacing to 7/72"	ESC 1	27 49
Set Spacing to n/72" (n = 0 to 255)	ESC A n	27 65 n
Store Spacing Set by ESC A n	ESC 2	27 50
Set Spacing to n/144" (n = 1 to 127)	ESC A n ESC A n	27 65 n 27 65 n
Set Spacing to n/216" (n = 0 to 255)	ESC A n ESC A n	27 65 n 27 65 n
Overscore On	ESC _ 1	27 95 49
Overscore Off	ESC _ 0	27 95 48
Paper Out Sensor Off	ESC 8	27 56
Paper Out Sensor On	ESC 9	27 57
Print Quality, Select HSD	ESC # 0	27 35 48
Print Suppress On, ML320T	ESC Q ETX	27 81 3
Print Suppress On, ML321T	ESC Q SYN	27 81 22
Print Suppress Off	DC1	17
Proportional Spacing On	ESC P 1	27 80 49
Proportional Spacing Off	ESC P 0	27 80 48
Reset: Clear Print Buffer	CAN	24
Software I-Prime	ESC } NUL	27 125 0

IBM Command	ASCII	Decimal
Stop Printing	ESC j	27 106
Subscript On	ESC S 1	27 83 49
Superscript On	ESC S 0	27 83 48
Subscript/Superscript Off	ESC T	27 84
Top of Form, Set at Current Position	ESC 4	27 52
Underline Printing On	ESC - 1	27 45 49
Underline Printing Off	ESC - 0	27 45 48
Uni-Directional Print On	ESC U 1	27 85 49
Uni-Directional Print Off	ESC U 0	27 85 48
Vertical Tab, Execute	VT	11

## Oki Data MICROLINE Standard Commands

Oki Data Command	ASCII	Decimal
Backspace	BS	8
Carriage Return	CR	13
Character Pitch		
Select 10 cpi	RS	30
Select 12 cpi	FS	28
Select 15 cpi	ESC g	27 103
Select 17.1 cpi	GS	29
Select 20 cpi	ESC # 3	27 35 51
Character Sets		
Standard	ESC ! 0	27 33 48
Block Graphic	ESC ! 1	27 33 49
Line Graphics	ESC ! 2	27 33 50
Publisher	ESC ! Z	27 33 90
Slashed Zero	ESC ! @	27 33 64
Unslashed Zero	ESC ! A	27 33 65
Double Height On	ESC US 1	27 31 49
Double Height Off	ESC US 0	27 31 48
Double Width Printing	US	31
Emphasized Printing On	ESC T	27 84
Emphasized Printing Off	ESC I	27 73

Oki Data Command	ASCII	Decimal
Enhanced Printing On	ESCH	27 72
Enhanced Printing Off	ESC I	27 73
Form Feed	FF	12
Horizontal Tab, Execute	HT	9
Italic On	ESC ! /	27 33 47
Italic Off	ESC ! *	27 33 42
Line Feed Commands		
w/ Carriage Return	LF	10
w/o Carriage Return	ESC DC2	27 18
n/144" (n = 0 to 127)	ESC % 5 n	27 37 53 n
Reverse	ESC LF	27 10
Line Spacing		
Set Spacing to 1/6"	ESC 6	27 54
Set Spacing to 1/8"	ESC 8	27 56
Set Spacing, in n/144" (n = 0 to 127)	ESC % 9 n	27 37 57 n
Skip Over Perforation, in 1/3" increments (n = 1 to 9)	ESC G nn	27 71 nn
Skip Over Perforation Default	ESC % S 0	27 37 83 48

## Okidata MICROLINE Standard Commands (Continued)

Okidata Command	ASCII	Decimal
Paper Out Sensor Off	ESC E 1	27 69 49
Paper Out Sensor On	ESC E 0	27 69 48
Print Quality		
Select HSD/SSD	ESC # 0	27 35 48
Select NLQ Courier	ESC 1	27 49
Select NLQ Gothic	ESC 3	27 51
Select Utility	ESC 0	27 48
Print Speed, Set to Full	ESC >	27 62
Print Speed, Set to Half	ESC <	27 60
Print Suppress On	DC3	19
Print Suppress Off	DC1	17
Proportional Printing		
On	ESC Y	27 89
Off	ESC Z	27 90
Reset: Clear Print Buffer	CAN	24
Shift-In	SI	15
Shift-Out	SO	14
Software I-Prime	ESC } NUL	27 125 0
Subscript Printing On	ESC L	27 76
Subscript Printing Off	ESC M	27 77
Superscript Printing On	ESC J	27 74
Superscript Printing Off	ESC K	27 75

Okidata Command	ASCII	Decimal
Underline Printing On	ESC C	27 67
Underline Printing Off	ESC D	27 68
Uni-Directional Print On	ESC -	27 45
Uni-Directional Print Off	ESC =	27 61
Vertical Tab, Execute	VT	11

# Warranty, Regulatory, and Safety Information

## Limited Warranty: United States and Canada

Oki Data Americas, Inc. (Oki Data) warrants this printer to be free from defect in material and workmanship and will remedy any such defect according to the terms of this *Limited Warranty*. This *Limited Warranty* does not extend to consumable items, including but not limited to ribbons, fuses, etc.

Oki Data will repair (or at its option, replace) at no charge, any defective component(s) of the printer for one (1) year from the date of purchase. This *Limited Warranty* extends to the original purchaser only.

To make request or claim for service under this *Limited Warranty* the original purchaser must return the Oki Data product, shipping prepaid, in the original shipping container or equivalent, to Oki Data or an authorized Oki Data service center and assume the risk of loss or damage in transit. A written receipt for the product, showing the date of purchase, dealer's name, and both the model and serial numbers of the Oki Data printer must accompany any request or claim for work to be performed under this *Limited Warranty*.

This *Limited Warranty* shall not apply if the product has been damaged due to abuse, misuse, misapplication, accident, or as a result of service or modification by any other than an authorized Oki Data service center.

THERE ARE NO EXPRESS WARRANTIES OTHER THAN THOSE ON THE FACE HEREOF AND DESCRIBED ABOVE. NO WARRANTIES WHETHER EXPRESS OR IMPLIED, INCLUDING, BUT NOT LIMITED TO, ANY IMPLIED WARRANTIES OF MERCHANTABILITY OR FITNESS FOR A PARTICULAR PURPOSE, SHALL EXTEND BEYOND THE RESPECTIVE WARRANTY PERIOD DESCRIBED ABOVE OF ONE (1) YEAR. Some states do not allow limitations on how long an implied warranty lasts, so the above limitation may not apply to you.

OKI DATA SHALL NOT BE RESPONSIBLE OR LIABLE FOR ANY SPECIAL, INCIDENTAL OR CONSEQUENTIAL DAMAGES OR LOSS ARISING FROM THE USE OF THIS PRODUCT. Some states do not allow the exclusion or limitation of incidental or consequential damages, so the above exclusion may not apply to you.

Additional information on obtaining service under this *Limited Warranty* is available by contacting the Oki Data dealer from whom the product was purchased, by contacting Oki Data directly at 1-800-654-3282 (1-800-OKI-DATA) [U.S. and Canada, English only] or at 1-856-222-7496 (Spanish only), or by contacting one of the listed service locations.

This *Limited Warranty* applies to this Oki Data printer. However, the procedure for obtaining service may vary outside the continental United States. Contact your Oki Data dealer for such warranty service information.

This warranty gives you specific legal rights, and you may also have other rights which vary from state to state.

## Limited Warranty: Latin America

Oki Data warrants this printer (hereinafter Product) to be free in defect in material and workmanship and will remedy any such defect according to the terms of this *Limited Warranty*. This *Limited Warranty* does not extend to consumable items, including but not limited to ribbon cartridges, fuses, etc.

Oki Data will repair (or at its option replace) at no charge, any defective component(s) of the Product for one (1) year from the date of purchase except for the consumable items, including but not limited to ribbons, fuses, etc. This *Limited Warranty* extends to the original purchaser only.

To make a request or claim for service under this *Limited Warranty* the original purchaser must return the Oki Data Product to Oki Data or an authorized Oki Data service center within the country purchased. The purchaser returning the Product for repair must pay for all transportation charges to the repair center. A written receipt for the Product, showing the date of purchase, dealer's name, and both the model and serial numbers of the Oki Data Product must accompany any request or claim for work to be performed under this *Limited Warranty*.

This shall not apply if the Product has been damaged due to abuse, misuse, misapplication, accident, or as a result of service or modification by any other than an authorized Oki Data service center.

THERE ARE NO EXPRESS WARRANTIES OTHER THAN THOSE ON THE FACE HEREOF AND DESCRIBED ABOVE. NO WARRANTIES, WHETHER EXPRESS OR IMPLIED, INCLUDING, BUT NOT LIMITED TO, ANY IMPLIED WARRANTIES OF MERCHANTABILITY OR FITNESS FOR A PARTICULAR PURPOSE, SHALL EXTEND BEYOND THE RESPECTIVE WARRANTY PERIODS NOTED ABOVE.

## **Service and Support: United States and Canada**

Oki Data is firmly committed to the satisfaction of our customers. If you have a problem that your customer documentation cannot solve, contact the listed sources for service or support.

### **Sales and Service Dealers: United States and Canada**

Consult the store location where you purchased your machine, or contact Oki Data for the location of the nearest Authorized Oki Data Service Dealer.

- Prices and minimum charges may vary.
- Proof of purchase is required for warranty work. Be sure to retain your purchase documents.

## **Telephone Support: United States and Canada**

### **Oki Data Customer Information System**

#### **Information System Automated Attendant**

1-800-654-3282 (1-800-OKI-DATA)

Toll Free in the U.S. and Canada

For quick answers to commonly-asked questions, the Oki Data Information System Automated Attendant is available 24 hours a day, 7 days a week. The system can provide immediate assistance with:

- Basic operating procedures
- Sales and service referrals
- Parts and consumable referrals
- Product information

#### **Customer Support Professionals**

1-800-654-3282 (1-800-OKI-DATA)

Toll Free in the U.S. and Canada

Customer Support Professionals are available 24 hours a day, 7 days a week. Please be sure that you are calling from a telephone close to your machine so you can describe your problem accurately.

Our Customer Support Professionals are trained on all current OKI products. They can answer your questions regarding:

- Locations of sales and service dealers
- Installation of your machine
- Usage/normal maintenance of your machine
- Error message interpretation/solutions
- Parts and supplies identification
- Consumer relations



## Service and Support: Latin America

Oki Data is committed to offer the best customer support possible to our customers. In the instance of having a difficult problem with your OKI product, please contact any of the OKI- CAS (Centro Autorizado de Servicio) shown on our Web site, [www.okidata.com](http://www.okidata.com).

### Sales and Service Centers: Latin America

If you need to service your OKI product, please contact the store where you bought your product or contact any of the OKI-CAS listed on our Web site for information.

- Prices and charges may vary.
- A copy of the proof of purchase is required for the warranty process.

### Contacting Oki Data: Latin America

Information regarding our products and authorized service centers is available in our Web site:

<http://www.okidata.com>

### Customer Support Professionals: Latin America

Our CAS's are trained and certified to provide the best service and support possible to our customers. Make sure that you are close to your machine when you call one of our OKI authorized service centers (OKI-CAS) so that you can describe your problem more accurately.

Our customer support professionals are trained on all current OKI products. They can answer your questions regarding:

- Location of nearest CAS (Service Center).
- Installation of your machine.
- Usage/normal maintenance of your machine.
- Error message interpretation/solutions
- Parts and supplies identification.
- Consumer relations.

## Oki Data on the Internet

### **www.okidata.com**

#### **Your Gateway to OKI Products and Services**

www.okidata.com is Oki Data's web site. It provides general information about all of the OKI products and services available to you.

You can use our web site to

- get Web-based support for all OKI products: 24 hours a day, 7 days a week—no waiting!
- download the printer drivers you need.
- read about other customers and how they use OKI products to improve their productivity and enhance their documentation.
- use the Dealer Locator to find a dealer location close to you.
- find out about Oki Data's special promotional offers and breaking news.
- and more . . .

### **my.okidata.com**

#### **Your Personal Solutions Center**

my.okidata.com is a powerful area of Oki Data's web site designed to help you personalize the information and service you get from Oki Data.

When you register for my.okidata.com, you

- personalize the web-based support for the OKI products you own: 24 hours a day, 7 days a week—no waiting!
- automatically register your product.
- access on-line versions of your product documentation (manuals) and support information.
- control your contact, profile, and preference information.
- receive automatic notification of new printer drivers, key updates, and support information.
- track your e-mail support history.
- and more . . .

# Oki Data Service Centers

## Oki Data Authorized Service Providers

Oki Data has over 2,000 local Authorized Service Providers in North and South America.

For the most comprehensive, up-to-date listing of Oki Data authorized Service Centers:

- Consult our web site at **www.okidata.com**
- In the U.S. and Canada, call 1-800-654-3282 (1-800-OKI-DATA)
- In Latin America, contact the Latin America Service Coordinator at Oki Data's Corporate Headquarters at +856-222-7496 (Spanish only)

## United States

Oki Data Americas, Inc.  
2020 Bishops Gate Blvd.  
Mt. Laurel, NJ 08054  
Phone: 1-800-654-3282  
Fax: 1-856-222-5247

## Canada

Oki Data Americas, Inc.  
2735 Matheson Blvd. East, Unit 1  
Mississauga, Ontario  
Canada L4W 4M8  
Phone: 1-800-654-3282  
Fax: 1-905-238-4421

## Mexico

Oki Data de Mexico, S.A. de C.V.  
Mariano Escobedo No. 748-8 Piso  
Col. Anzures, e.p. 11590  
Mexico, DF  
Phone: (525) 263-8780  
Fax: (525) 250-3501

## Brazil

Oki Data do Brasil, Ltda.  
Rua Alexandre Dumas, 2220 - 8 andar  
Chácara Sto Antonio  
São Paulo, Brazil 04717-004  
Phone: 55-11-3444-3500  
Fax: 55-11-3444-3501

# Material Safety Data Sheet (MSDS)

**For Black Ribbon, P/N 52102001  
MSDS #58064801**

**Current as of March 1, 2001**

For more information, contact Oki Data at:

2000 Bishops Gate Boulevard  
Mount Laurel, NJ 08054-4620

## **Emergency Information: MSDS**

*United States and Canada*

*1-800-654-3282 (1-800-OKI-DATA)*

*English only*

*Latin America*

*+856-235-2600*

## **Emergency First Aid Procedures**

**Contact occurs with eyes.**

Flush eyes with large quantities of water for 15 minutes, keeping eyelids open with fingers. Seek medical attention.

**Contact occurs with skin**

Wash thoroughly with soap and water.

## **Hazardous Ingredients**

### **Carbon Black**

CAS# 1333-86-4

OSHA PEL 3.5 mg/m<sup>3</sup>

ACGIH TLV 3.5 mg/m<sup>3</sup>

### **Coloring Material**

CAS# N/A

OSHA TWAN/A

ACGIH TLV N/A

### **Oil**

CAS# N/A

OSHA TWAN/A

ACGIH TLV N/A

### **Additives**

CAS# N/A

OSHA TWAN/A

ACGIH TLV N/A

### **Nylon 6-6 Fabric**

CAS# N/A

OSHA TWAN/A

ACGIH TLV N/A

### **PSM Fiber**

CAS# N/A

OSHA TWAN/A

ACGIH TLV N/A

## Physical Data

**Melting Point:** N/A

**Boiling Point:** N/A

**Vapor Pressure:** N/A

**Vapor Density (Air = 1):** N/A

**Evaporation Rate (Butyl Acetate = 1):** N/A

**Specific Gravity (H<sub>2</sub>O=1):** No data available

**Solubility in Water:** No data available

**Appearance and Odor:** Nylon 6-6 fabric impregnated with liquid black ink

## Fire and Explosion Hazard Data

**Flash Point (Method Used):** N/A

**Flammable Limits, LEL/UEL:** N/A

**Extinguishing Media:** Water, CO<sub>2</sub>, Dry Chemical or Foam

**Special Fire and Explosion Procedures:** N/A

**Unusual Fire and Explosion Hazards:** None

## Health Hazard Data

**Routes of Entry:** Ingestion, Eyes, Skin

### Health Hazards:

#### 1 Carbon black

(Group 2B “Possible Carcinogen”; IARC)

Overexposure to carbon black is associated with causing irritation, conjunctivitis, and corneal hypoplasia of the eyes; minor irritation and eczema of the skin; and irritation and bronchitis. Long-term inhalation exposure may be associated with causing lung cancer.

### Reactivity Data

**Stability:** Stable

**Polymerization:** Will not occur.

**Hazardous Decomposition or Byproducts:** None

**Conditions to Avoid:** N/A

**Incompatibility (Materials to Avoid):** None

## Spill Cleanup and Disposal

### Spill Cleanup

If the ribbon is inadvertently pulled out, it should be rewound on the reel using the take-up knob.

### Waste Disposal

Follow appropriate federal, state and local regulations.

## Safe Handling and Use

**Respiratory Protection:** N/A

**Protective Gloves and/or Eye Protection:** Not normally required. Protective gloves desirable in some cases.

**Ventilation:** N/A

**Other Protective Equipment and/or Hygienic Practices:** N/A

## Special Precautions

**Precautions for Handling or Storage:** Store in a dark, cold place. Do not pull ribbon out of cartridge.

**Other Precautions:** N/A

---

To the best of the manufacturer's knowledge, the information contained herein is accurate. However, neither the manufacturer, nor any of its affiliates, make any representations or warranties (expressed or implied), nor assumes any liability (including liability for any direct, incidental, consequential, or other damages) with respect to the accuracy or completeness of the information contained herein. Such information may be (without limitation) invalid if the specified material is used in combination with another, in a particular process, or under unusual conditions. Determination of suitability of any material for any given purpose is the sole responsibility of the user who assumes all risk and responsibility therefor. All materials may present unknown hazards and should be used with appropriate caution. The manufacturer cannot and does not guarantee that the hazards described herein are the only ones that exist.

---

## Safety Information

Your OKI printer has been carefully designed to give you years of safe, reliable performance. As with all electrical equipment, there are a few basic precautions you should take to avoid hurting yourself or damaging the printer:

- Carefully read all setup and operating instructions. Be sure to save all documents for future reference.
- Read and follow all warning and instruction labels on the printer itself.
- Place your printer on a firm, solid surface. If you put it on something unsteady, it might fall and be damaged.
- Avoid overheating the printer. Do not place it on a soft surface, such as a rug, sofa, or bed. The vents may be blocked, causing the printer to overheat.
- The printer must be installed near a power outlet which will remain easily accessible.
- Be certain that your power source matches the rating listed on the back of the printer. If you aren't sure, check with your dealer or with your local power company.
- Your printer has a grounded, 3-prong plug as a safety feature. It will only fit into a grounded outlet. If you can not plug it in, chances are that you have an older, non-grounded outlet. Contact an electrician to have it replaced with a grounded outlet. Do not use an adapter to defeat the grounding.
- To avoid damaging the power cord, do not put anything on it or place it where it will be walked on. If the cord becomes damaged or frayed, replace it immediately.
- If you're using an extension cord or power strip with the printer, make sure that the total of the amperes required by all the equipment on the extension is less than the extension's rating. Generally, the total ratings of all equipment plugged into any one power line should not exceed 15 amperes. Don't exceed this unless you know that the power line your equipment is plugged into has a rating above 15 amperes.
- Unplug the printer before you clean it. Use only a damp cloth. Do not use liquid or aerosol cleaners.
- To protect your printer from overheating, make sure no openings on the printer are blocked. Do not put the printer on or near a heat source, such as a radiator or heat register. If you put the printer in any kind of enclosure, make sure it is well ventilated.
- The printhead can get quite hot when it has been printing for a length of time. Do not touch the printhead until it has had a chance to cool off.
- Do not use your printer near water. Do not spill liquid of any kind into it.



- Do not poke anything into the ventilation slots on the sides of the printer. You could get a shock or cause a fire.
- Aside from the routine maintenance described in this document, don't try to service the printer yourself. Opening the cover may expose you to shocks or other hazards. Don't make any adjustments other than those outlined in the document. You might cause damage requiring extensive repair work.
- If anything happens that indicates that your printer is not working properly or has been damaged, unplug it immediately. Then, follow the procedures in "Service and Support" for having your printer serviced. These are some of the things to look for:
  - The power cord or plug is frayed or damaged.
  - Liquid has been spilled into the housing, or the printer has been exposed to water.
  - The printer has been dropped or its cabinet has been damaged.
  - The printer doesn't function normally when you're following the operating instructions.

## Regulatory Information

### Year 2000 Compliance

The Microline 320/321 Turbo is Year 2000 Compliant. It contains information technology that accurately processes date and time data between the years 1999 and 2000, and carries no issue for the September 9, 1999 (9999) programming concern. This product, when used in combination with products purchased from other manufacturers, whose products properly exchange data and time information, will accurately process the date and time.

### ENERGY STAR®



As an ENERGY STAR Partner, Oki Data has determined that this product meets the ENERGY STAR guidelines for energy efficiency.

## Federal Communications Commission (FCC)

### FCC Radio Frequency Interference Statement for 120-Volt Models

WARNING: This equipment has been tested and found to comply with the limits for a Class B digital device, pursuant to Part 15 of the FCC rules. These limits are designed to provide reasonable protection against harmful interference in a residential installation. This equipment generates, uses and can radiate radio frequency energy and, if not installed and used in accordance with the instructions, may cause harmful interference to radio communications. However, there is no guarantee that interference will not occur in a particular installation. If this equipment does cause harmful interference to radio or television reception, which can be determined by turning the equipment off and on, the user is encouraged to try to correct the interference by one or more of the following measures:

- Reorient or relocate the receiving antenna.
- Increase the separation between the equipment and the receiver.

- Plug the unit into an outlet on a circuit different from that to which the receiver is connected.
- Consult the dealer or an experienced radio/television technician for help.

! ***It is the responsibility of the user to obtain the required shielded cable in order to ensure compliance of this equipment with FCC regulations.***

Changes or modifications not expressly approved by Oki Data may void your authority to operate this device.

## **FCC Radio Frequency Interference Statement for 230/240-Volt Models**

WARNING: This equipment has been tested and found to comply with the limits for a Class A digital device, pursuant to Part 15 of the FCC rules. These limits are designed to provide reasonable protection against harmful interference in a commercial environment. This equipment generates, uses and can radiate radio frequency energy and, if not installed and used in accordance with the instructions, may cause harmful interference to radio communications. Operation of this equipment in a residential area is likely to cause harmful interference in which case the user will be required to correct the interference at their own expense.

- ! *It is the responsibility of the user to obtain the required shielded cable in order to ensure compliance of this equipment with FCC regulations.*

Changes or modifications not expressly approved by Oki Data may void your authority to operate this device.

## **Industry Canada (IC)**

### **IC Radio Interference Statement for 120-Volt Models**

This Oki Data apparatus complies with the Class B limits for radio interference as specified in the Industry Canada Radio Interference Regulations.

### **IC Radio Interference Statement for 230/240-Volt Models**

This Oki Data apparatus complies with the Class A limits for radio interference as specified in the Industry Canada Radio Interference Regulations.

## **European Union Council of the European Communities**

### **Statement of Electromagnetic Conformance for 230/240-Volt Models**

This product complies with the requirements of the Council Directive 89/336/EEC on the approximation of the laws of the member states relating to electromagnetic compatibility.

### **Statement of Safety Conformance for 230/240-Volt Models**

This product is in conformity with Directive 73/23/EEC on the harmonization of the laws of Member States relating to electrical equipment designed for use within certain voltage limits.

# Index

## Symbols

0 character (slashed, unslashed) 65, 72  
10 cpi (Front Panel Light) 17, 60  
12 cpi (Front Panel Light) 17, 60  
120 volt printer 90  
15 cpi (Front Panel Light) 17, 60  
17 cpi (Front Panel Light) 17, 60  
20 cpi (Front Panel Light) 17, 60  
230 or 240 volt printer 90  
300 cps (UTL) 86  
390 cps (HSD) 86  
435 cps (SSD) 86  
75 cps (NLQ) 86

## A

ABICOMP 65, 70  
Access  
    Controlling access to the printer 11  
Access Cover, Part Number 100  
Accessories 98, 99  
    Part Numbers 99  
    Purchasing 98  
Acoustic Cover, Part Number 100  
Alarm  
    ALARM flashing 17, 32, 84  
    ALARM lit 17  
    ALARM lit, CPI 10 flashing 84  
    ALARM lit, CPI 15 flashing 85  
Alignment problems 11  
ASCII Test 36  
Auto Carriage return 70  
Auto CR+ 68  
Auto LF (Line Feed) 68, 70  
Auto Select 68

## B

Backward  
    Movement through Menu 9  
Bar Codes 87  
Bi-directional  
    Communications 27  
    Printing 67, 71  
Block Graphics 65, 70  
Bottom Feed 88, 89, 90  
    Form Tear-Off 66  
    Line Spacing 66  
    Pull Tractor (Option) 99  
    Skip Over Perforation 66  
BRASC II 65, 70  
Brazil 95, 115  
British (Language) 65  
Buffer  
    Clearing 18, 71  
    Print 71  
    Receive Buffer Size 67, 72, 87

## C

### Cable

- Length 27
- Parallel 27
- Serial Interface 27
- Shielded 27

### Canada

- Customer Support 112
- Locating a service center 115
- Service 94, 96, 111
- Service Center (Oki Data) 95, 115
- Warranty 108

### Canadian French 65, 70

### Carbon Forms 53

### Carbonless continuous forms 88, 89

### Cardstock 88, 89

- Expanded printhead gap 54

### Centering 68, 70

- Printhead Position 84

### Centronics parallel interface 86

### Character Pitch 71

- Front Panel key 18
- Indicator Lights 17
- Key doesn't work 85
- Selecting 60

### Character Set 65, 70

### Character Width 71

### Characters

- Italics 72
- Proportional Spacing 72
- Special for languages 71

### Characters Per Second (CPS) 13

### Cleaning the printer 74

### Code 128 87

### Code 39 87

### Code DEL 68

### Code Page Character Set 70

### Codes, Printer Control 101

### Commands

- Epson FX Commands 102, 103
- IBM Proprinter III Commands 104
- Microline Standard 106, 107

### Compatibility 13

### Computer connections 27

### Consumables

- Part Numbers 99, 100
- Ribbon Cartridge 99
- Ribbon Life 87

### Contact Information for Oki Data 2

### Contents list, unpacking the printer 23

### Continuous Feed

- Carbonless Forms 88, 89
- Changing to single-sheet feed 52
- Extra-thick forms 53
- Interleaf continuous forms 88, 89
- Paper 85
- Paper Park 18
- Pins (graphic) 29
- Rear Feed 15
- Reference Mark 30
- Single-part forms 29, 88, 89

### Control Codes 101

### Correspondence, Print Quality 58

### Costs, Cutting 8

### Courier (Font) 58, 87

### Covers, Part Numbers 100

### cpi 10 flashing, ALARM lit 84

### cpi 15 flashing, ALARM lit 85

### Customer Support

- Canada 112
- Latin America 113
- United States 112

### Cut Sheet Feeder 99

### Cut Sheet Paper 88, 89

### Cutting Costs. *See* Money, Saving

## D

- Danish (Language) 65
- Data Word 70
  - 7 bit 68
  - 8 bit 68
- DC1 code 72
- DC3 code 72
- DEL Code 71
- Depth of printer 90
- Detergent, cleaning the housing 74
- Documents, Print Quality 58
- Draft
  - Draft Mode 65, 86
  - Print Quality 58
- Draft Mode
  - Saving money with 8
  - Saving time with 9
- Drivers
  - Diskette 37
  - Oki Data Web Site 37
  - Operating Systems 37
  - Requesting by mail 37
- Dutch (Language) 65

## E

- E-mail address for Oki Data 2
- EAN 13 87
- EAN 8 87
- Efficiency. *See* Time, Saving
- Electrical Requirements 90
- Electromagnetic Conformance 124
- Emergency Information 116
- Emulation 33, 65
  - Changing 33
  - Choices 33, 86
  - Matching the printer driver 83
  - Mode 65, 70
- Energy Star 121
- Envelopes 31
  - Continuous Feed 88, 89
  - Printhead Gap Setting 53
  - Single Feed 88, 89
- Environmental Requirements 90
- Epson
  - Emulation Mode, Epson FX 33, 65, 86
  - Epson FX Commands 102, 103
- Error Conditions
  - ALARM blinks 17
  - ALARM glows 17

- ESC SI Pitch 70
- European Union Council of the European Communities 124
- Expanded Printhead Gap 54

## F

- Factory Defaults
  - Menu Mode 63
- FCC (Federal Communications Commission) 122
- FF/LOAD (Front Panel Key) 18
- First Aid Procedures 116
- Fonts
  - Embedded Printer Commands 83
  - Font Sample Test 18, 35
  - PRINT QUALITY key 18
  - Resident 87
  - Scalable 87
  - Size 60, 65, 87
  - Style 65
  - Wrong fonts print 37, 83

## Forms

### Continuous

Carbonless 88, 89

Interleaf 88, 89

Single-part 88, 89

Multipart and Printhead Gap 53

Narrow width 84

Thick 54

Thickness ranges 13

Zero-Tear 13

### Forms Tear-Off 71

Automatic 48

Bottom Feed 66

Changing 47

### Forms Tear-Off OFF

TEAR key 50

Top of Form 42

### Forms Tear-Off ON

TEAR key 50

Top of Form 40

Manual 49

Rear Feed 66

Saving money with 8

Status (ON or OFF) 39

TEAR key 18, 48

Top of Form 39

Wait Time 72

French (Language) 65

French Canadian (Language) 65

### Front Panel

Keys 11, 18, 68

Alternate Functions 18

Won't work 11, 68, 71

Lights 17

Menu Mode 61

## G

German (Language) 65

Gothic (Font) 87

HSD Print Quality 58

Near Letter Quality 58

SSD Print Quality 58

Utility Print Quality 58

Graphics 70

7 bit 67

8 bit 67

Printing 71

Bi-directional 67

Uneven print registration

46, 47, 48

Uni-directional 67

Resolution 87

GROUP, Menu Mode 61



## H

- Height
  - Double height printing 72
  - of Printer 90
- Help. *See* Service and Support
- High Speed Draft
  - HSD Front Panel Light 17
  - Mode 13, 86, 87
  - Print Quality 58
- Humidity
  - Operating 90
  - Storage 90

## I

- I-Prime 69, 71, 82
- IBM
  - IBM 437 70
  - IBM 850 70
  - IBM 860 70
  - IBM 863 70
  - IBM 865 70
  - IBM Emulation 33
  - IBM PPR 65
  - IBM Proprinter III 86
  - IBM Proprinter III Commands 104
  - IBM Set I 70
  - IBM Set II 70
- IC. *See* Industry Canada
- IEEE-284 86
- Impact Dot Matrix 86
- Industry Canada 123
- Initialization string 82
- Initialize the printer 59
- Installation
  - Customization 21
- Interface 86
  - Serial Interface (Option) 99
- Interleaf Continuous Forms 88, 89
- Interleaved 2 of 5 87

- Internet 12
  - Oki Data Web Site
    - 2, 93, 95, 97, 113, 114, 115
    - Saving time with 9
- Invalid (I-Prime command) 71
- Italian (Language) 65
- Italic 65, 72
- Item, Menu Mode 61
  - Explanations of Items 70, 71, 72
  - Settings 61

## J

- Japanese (Language) 65

## K

- Keys, Front Panel 18

## L

- Labels 88, 89
  - Paper Park 51
  - Printhead Gap Setting 53
- Language 65, 71
- Latin America
  - Customer Support 113
  - Language 65
  - Locating a service center 95, 115
  - Service 97
  - Warranty 110
- Length, Page
  - Bottom Feed 66
  - Control, Top Feed 67
  - Rear Feed 66
  - Top Feed 67
- Letterhead 31
- LF, Front Panel key 18
- Lights, Front Panel 17
- Limited Operation 11, 71, 85
- Line Graphics 65, 70
- Line Spacing 71
  - Bottom Feed 66
  - Rear Feed 66
  - Top Feed 67
- Lock Lever (graphic) 29

## M

- Mailing address for Oki Data 2
- Maintenance
  - Cleaning the printer housing 74
  - Replacing the ribbon cartridge 73
- Margin, Bottom 67, 70
- Material Safety Data Sheet (MSDS) 116
- Mean Time Between Failures (MTBF) 13, 87
- Mean Time to Repair (MTTR) 87
- Memory, Receive Buffer size 67, 72, 87
- Memos 31
- MENU light 61
- Menu Mode 61
  - Changing Settings 64
  - Entering 62
  - Exiting 62
  - Explanations of Menu Items 70, 71, 72
  - Front Panel keys 61
  - Group 61
  - Item 61
  - Losing setting changes 64
  - MENU light 61
  - Moving Backward 62
  - Moving Forward 62
  - Moving through 9, 62
  - Printing the Menu Settings 63
  - Reset to factory defaults 63
  - Saving time 9
  - SEL and SHIFT keys 18
  - SEL on power up 18
  - Set (Item Setting) 61
  - Settings Table 65, 66, 67, 68, 69
- Mexico 95, 115
- Microline Reference Manual 101
- Microline Standard Commands 106, 107
- ML Emulation Mode 65
- Money, Saving 8
- Moving through the menu 9
- MSDS. *See* Material Safety Data Sheet
- Multilingual 65, 70

## N

- Near Letter Quality 58
- NLQ 86, 87
- NLQ Front Panel Light 17
- Norwegian 70
  - Code Page 65
  - Language 65

## O

- Off-line, SEL key 18
- Oki Data
  - Contact Information
    - e-mail 2
    - Latin America 95
    - mailing address 2
    - telephone 94, 95, 98, 112
  - Microline Commands 106, 107
  - Microline Emulation 33, 86
  - Service Centers 95, 115
  - Web Site 2, 113, 115
- On-line, SEL key 18
- Operating Systems 37
- Operator Panel Function 85

- Options 98
  - Descriptions 99
  - Part Numbers 99
  - Purchasing 98
- Out of Paper
  - ALARM glows, no other lights 17

## P

- Packing for Shipment 24
- Page Length 71
  - Bottom Feed 66
  - Rear Feed 66
  - Top Feed 67
- Page Width 71
  - Bottom Feed 66
  - Rear Feed 66
  - Setting in the Printer Menu 67, 71
  - Top Feed 67

## Paper

- 1" (25 mm) remains 71
- Continuous Feed
  - Alignment 30
  - Rear Feed 29
- Cut Sheet 99
- Feeding 13
- Loading 29
- Paper Out Override 67, 71
- Roll Paper 99
- Single Sheet 29, 31
- Specifications
  - ML320 Turbo 88
  - ML321 Turbo 89
- Static 85
- Thickness 90
- Types, and Printhead Gap 53
- Weight 88, 89
- Widths 88, 89
  - Setting in the Printer Menu 67, 71

- Paper Feed
  - Continuous to single-sheet feed 52
  - Cut Sheet Feeder (Option) 99
  - FF/LOAD key 18
  - LF key 18
  - PARK key 18
  - QUIET key 18
  - Roll Paper Stand (Option) 99
  - Single-sheet to continuous-feed 52
  - Switching feed paths 52
  - TEAR key 18
- Paper Jams 85
  - ALARM glows, 15 cpi blinks 17
  - Continuous feed 85
  - Rear Feed 75
  - Rear Feed, repetitive 77
  - Single Sheet 79
- Paper Lever 84
  - ALARM glows, 10 cpi blinks 17
  - REAR feed position (graphic) 29
- Paper Out 85
- Paper Park 51
  - Labels 51
  - Saving time with 9
- Paper Path, Switching 52
- Paper Separator 85
- Parallel Interface 69
  - I-PRIME Signal 82
- PARK Front Panel Key 18, 31
- Parts, Replacement 98
  - Part Numbers 99
  - Purchasing 98
- Perforation, Skip over 66, 72
- Pin 14 70
- Pin 18 69, 71
- Pitch, Character 65, 71
- Platen Knob
  - Operation Tip 11
  - Part Number 100
- Portugal 65, 70
- Postnet 87
- Power
  - Connecting the printer to 28
  - Front Panel Light lit 17
  - Grounded Outlets 19, 120
  - Nothing happens when printer is turned on 83
  - Power Rating 19, 120
- Print DEL code 68
- PRINT, Menu Mode 61
- Print Method 86
- Print Mode 65, 71
- Print Quality
  - ASCII Test 36
  - CHARACTER PITCH key 18
  - Font Sample Test 35
  - Front Panel key 18
  - Highest (NLQ) 58
  - Indicator Lights 17
  - key doesn't work 85
  - Low (HSD) 58
  - Lowest (SSD) 58
  - Medium (UTL) 58
  - Near Letter Quality 86
  - PRINT QUALITY key 18
  - Print Speed 13
  - Proportional Spacing 72
  - Selecting 58, 71
  - Software commands 58

- Print Registration 67, 71
  - Forms Tear-Off 46, 47, 48
  - Shift left 67
  - Shift right 67
- Print Server Option 99
- Print Size 86
  - Smallest 60
  - Standard 60
- Print Speed 13, 86
  - High (HSD) 58
  - Highest (SSD) 58
  - Medium (UTIL) 58
  - Selecting 71
  - Slowest (NLQ) 58
- Print Start Position
  - Reset to factory default position 45
  - Temporary adjustment 44
  - Top of Form 38, 44, 45
- Print Suppress 68, 72

- Printer
  - Dimensions 90
  - Humidity Specifications 90
  - Initialization 59
  - Model Number 98
  - Parameters 9
  - Parts and Accessories 98, 99
  - Printer vs. software settings 82
  - Reset 59
  - Resetting 18
  - Serial Number 14
  - Size 90
  - Temperature Specifications 90
  - Weight 90
- Printer Control Codes 101
- Printer Drivers
  - matching the emulation 83
  - Obtaining 37
  - Operating systems 37
  - Selecting 37
- Printer Parameters 61

- Printhead 86
  - Centering position 70, 84
  - Heat 120
  - Life 87
  - New printhead 84
  - Part Number 100
- Printhead Gap 13
  - Definition 53
  - Expanded 54
  - Extra-thick continuous forms 53
  - Setting 53
  - Settings, and Media types 53
- Printing
  - Double width and height 72
  - Embedded Commands 83
  - Italics 72
  - Problems
    - Files don't print correctly 82
    - Incorrect fonts print 37, 83
    - Printer doesn't print 83
    - Smearred print 84
    - Strange characters print 37
    - Strange symbols print 83
    - Streaked printing 84
  - Stopping 67, 72, 87

Productivity. *See* Money,  
Saving; Time, Saving

Proof of Purchase 96

#### PROP

characters per inch (cpi) 60

Front Panel Light 17

Proportional Spacing 60, 65, 72

Proprinter III Commands 104

Publisher (Language Set) 65

Pull Tractor 13, 53, 90, 99

Pull-Up Roller Assembly 100

Push Tractor 13, 53, 90, 99

## Q

#### QUIET

Front Panel Key 18

Front Panel Light 17

## R

Radio Interference Statement 122, 123

Rear Feed 88, 89, 90

Continuous Forms 15, 29

Form Tear-Off 66

Jams, Repetitive 77

Line Spacing 66

Paper Jam 75

Skip Over Perforation 66

Receive Buffer size 67, 72, 87

Registration, Print 67, 71

Regulatory Information

Canada 123

Europe 124

United States 122

Reliability 13, 87

Replacement Parts 98, 99

Part Numbers 100

Reset 68

Reset Code 82

Reset Inhibit 72, 82

the printer 59, 85

Resolution (Graphics) 87

Reverse

Movement through Menu 9

Ribbon Cartridge 99

Installing 25

Life 87

New Ribbon Cartridge 84

Part Number 100

Replacing 25, 73

Ribbon Shield 25, 84

Roll Paper Stand 99

Rolling ASCII Test 18

RS-232C Serial Interface 86

## S

- Safety, General Information 120
- Saving Money. *See* Money, Saving
- Saving Time. *See* Time, Saving
- Security
  - Controlling access to the printer 11
- SEL
  - Front Panel Key 18
  - Front Panel Light
    - Flashes 17
    - Lit 17
    - Not Lit 17, 83
- Self Tests 34
- Serial Interface Option 83, 99
- Serial Number 14
- Server
  - Print Server (Option) 99
- Service
  - ALARM flashing 84
  - Locating a service center 97
    - Canada 111
    - Latin America 97
    - United States 94, 96, 111
  - Machine Reliability 87
  - Mean Time Between Failures (MTBF) 13, 87
  - Mean Time To Repair (MTTR) 87
  - Warranty 108, 110
- Service and Support 91
  - Documentation 92
  - General Information 91
  - Internet Support 93
  - Purchase Location 92
  - Telephone Support 94
- Service Centers
  - Authorized Service Centers 95, 111, 113, 115
  - Locating a service center 115
    - Oki Data 95, 115
- Set, Menu Mode 61
- SHIFT Front Panel Key 18
- Shipping
  - Restraints 24
  - Saving the packing materials 24
- SI 68, 72
- Single Sheet
  - Change from continuous forms 52
  - Change to continuous forms 52
  - Cut Sheet Feeder (Option) 99
  - Jams 79
  - Loading 31
  - Top Feed 16, 29
- Size
  - Double width and height 72
  - of printer 90
- Skip Over Perforation 66
- Software
  - Embedded commands 83
  - Matching drivers to emulations 83
  - Scalable Fonts 87
  - Software vs. printer settings 82
- Solvents, cleaning 74
- Spanish (Language) 65
- Specifications 86
- Spreadsheets, Character Pitch 60

## SSD

Front Panel Light 17, 86, 87

Standard Character Set 65, 70

Static charges and paper 85

Stationery 31

Super Speed Draft 13, 58, 59, 70

Support 91

Documentation 92

General Information 91

Internet Support 12, 93

Purchase Location 92

Telephone Support 94

Swedish (Language) 65

Symbol Sets 65, 71

## T

Take-up Knob (Ribbon Cartridge) 25

### TEAR

Front Panel key 18, 50

Forms Tear-Off 48

Forms Tear-Off OFF 50

Forms Tear-Off ON 50

TEAR feature 46

does not work

46, 47, 48, 49, 50

### Telephone

Oki Data Support 94, 95, 98

Latin America 95

Temperature Specifications 90

### Tests

ASCII Test 36

Font Sample Test 35

Thickness, Paper 90

Time Out 68, 72

Time, Saving 9

Top Feed 88, 89

Bottom Margin 67

Line Spacing 67

Pull Tractor 99

Single Sheet 16, 29

Top of Form 70

Decreasing the space 41, 43

Forms Tear-Off 39

Forms Tear-Off OFF 42

Forms Tear-Off ON 40

Increasing the space 41, 43

Operation Tip 10

Paper Shield 10, 38

Reset to factory default 45

Printer OFF 45

Printer ON 45

Setting 38

Standard Setting

31, 32, 38, 44, 45

Temporary adjustment 44

Tractor Covers 29

Transparencies 88, 89



## Troubleshooting

- Aborting print jobs 67, 72, 87
- ALARM flashing 17, 84
- ALARM lit 17
- ALARM lit, 10 cpi flashing 17, 84
- ALARM lit, 15 cpi flashing 17, 85
- ALARM lit, no other lights 17
- Alignment problems 11
- Can't load paper 85
- Character Pitch Indicator Lights 17
- Data loss 70, 71, 72
- Embedded Printer Commands 83
- Emulation 83
- Extra paper movement 46, 47, 48
- Files don't print correctly 82
- Front Panel Keys 18
- Front Panel keys won't work 11, 68, 85
- Front Panel Lights 17
- General Information 80
- Internet Support 80
- List of Problems 81
- Locating a service center 97
- Menu Setting changes are lost 64

- Narrow forms 84
- New ribbon 84
- Oki Data Support (Telephone) 94, 95, 98
  - Latin America 95
- Oki Data Support (Web Site) 93, 95, 97, 114
- Paper jams, continuous feed 85
- Paper Out 85
- Perforation skip over 72
- POWER lit 17
- PRINT QUALITY and CHARACTER PITCH keys don't work 11, 71, 85
- Print Quality Indicator Lights 17
- Print Registration 67
- Printer doesn't print 83
- Printer Drivers, current version 37
- Printhead Damage 70, 71
- Printhead moves too much 84
- QUIET lit 17

## SEL

- flashing 17
- lit 17
  - not Lit 17
- Self Tests 34
- Smear printing 84
- Software settings vs. printer settings 58, 72
- SSD won't work 70
- Static charges 85
- Strange characters print 37
- Streaked printing 84
- Turn on the printer, nothing happens 83
- Uneven print registration in graphics 46, 47, 48
- Weather conditions 85
- Wrong fonts print 37, 83
- Wrong printer driver 37

## U

- Uni-directional printing, graphics 67
- United States
  - Customer Support 112
  - Locating a service center 115
  - Service 94, 96, 111
  - Service Center (Oki Data) 95, 115
  - Warranty 108
- Unpacking your printer
  - List of contents 23
- UPC A 87
- UPC E 87
- USA 65, 70
- UTIL (Front Panel Light) 17, 86, 87
- Utility
  - Utility Mode Print Quality 58
  - Utility Mode Print Speed 13

## V

- Volume
  - High-volume print quality 58

## W

- Wait Time 67, 72
- Warranty
  - Latin America 110
  - Proof of Purchase 96
  - United States and Canada 108
- Web Site, Oki Data 2
- Weight
  - Paper 88, 89
  - Printer 90
- Width
  - Character 71
  - Double width printing 72
  - Page (Bottom Feed) 66
  - Page (Rear Feed) 66
  - Page (Top Feed) 67
  - Paper 88, 89
    - Setting in the Printer Menu 67, 71
  - Printer 90
- [www.my.okidata.com](http://www.my.okidata.com) 93, 114
- [www.okidata.com](http://www.okidata.com)
  - 93, 95, 97, 113, 114, 115

## Y

- Y2K 121
- Year 2000 121

## Z

- Zero character (slashed, unslashed) 65, 72